

# **Express**<sup>®</sup>

## **ENCORE**<sup>™</sup>

***Model: EXE3***

*Express<sup>®</sup> EnCore<sup>™</sup> Battery Charger*

*Owner's Manual*

To automatically be connected to your closest Service Center, call us toll-free at:  
**1-800-ENERSYS (1-800-363-7797)**

I.B. 1660  
Rev AB 7/17

**IMPORTANT**

Read and understand your user's manual before installing, operating or servicing this product.

**DO NOT DESTROY THIS BOOK**

**TABLE OF CONTENTS**

<b>Important Safety Instructions</b> .....	<b>2</b>	Main Menu Display.....	16
<b>Technical Information</b> .....	<b>3</b>	Main Menu.....	16
Part Number.....	3	<b>Logs</b> .....	<b>17</b>
Output Power Letter Codes.....	4	Memorizations Display Screen.....	17
Cabinet Size/Gauge Letter Codes.....	4	Displaying a Charge Cycle.....	17
DC Voltage Number Codes.....	4	Memorization Data.....	17
AC Line Voltage Letter Codes.....	5	<b>Status</b> .....	<b>18</b>
Charge Profile Letter Codes.....	5	Status Screen.....	18
Specialty Charger Option List.....	5	<b>Charger</b> .....	<b>19</b>
Serial Number.....	5	Information.....	19
Battery Type.....	6	Charger Information Display.....	19
Max AH.....	6	<b>USB</b> .....	<b>20</b>
No. Cells.....	6	Update Software.....	20
Max Modules.....	6	<b>Settings</b> .....	<b>20</b>
Config Modules.....	6	Parameters.....	20
Hertz.....	6	Date/Time.....	20
Phase.....	6	Language.....	20
AC Volts.....	6	Region.....	20
Config AC Amps.....	6	Display.....	20
Max AC Amps.....	6	Screen Saver.....	20
Max DC Amps.....	6	Delay.....	20
DC Volts.....	6	Themes.....	21
Config DC Amps.....	7	Daylight Savings.....	22
CEC.....	7	<b>Password</b> .....	<b>22</b>
cULus.....	7	<b>Charging the Battery</b> .....	<b>23</b>
<b>Installation</b> .....	<b>8</b>	Charger Idle Display.....	23
Location.....	8	Starting a Charge Cycle.....	24
Cabinet Mounting.....	8	Delayed Start.....	24
Electrical Connections.....	8	Count Down Display.....	24
Connecting Input Power.....	8	Charger Display.....	25
AC Disconnect.....	9	End of Charge Display.....	26
Plug Polarity.....	9	End of Charge without Equalization.....	26
Grounding the Charger.....	9	End of Charge with Equalization.....	26
<b>Description of Operation</b> .....	<b>10</b>	Manual Equalization Start.....	26
General.....	10	Automatic Equalization Start.....	27
Starting the Charge Cycle.....	10	<b>Fault Codes</b> .....	<b>28</b>
Charging Current.....	10	Fault Display.....	28
AC Power Fail.....	10	<b>Maintenance and Service</b> .....	<b>30</b>
Series Charging.....	10	<b>Mounting Dimensions</b> .....	<b>31</b>
<b>Glossary</b> .....	<b>11</b>	3.5 kW 4 Bay Cabinet	
Wi-iQ® Device.....	11	Mounting Dimensions.....	31
Charging Profile.....	11	3.5 kW 6 Bay Cabinet Mounting	
Cold Storage Profile.....	11	Dimensions.....	32
Equalization Charging.....	11	3.5 kW 8 Bay Cabinet Mounting	
Gel-Bloc Profile.....	11	Dimensions.....	33
IONIC™ Profile.....	11	<b>Technical Specifications</b> .....	<b>34</b>
VRLA Profile.....	11	3.5 kW Standard Technical	
Opportunity Profile.....	11	Specifications.....	34
Operation.....	11	<b>Maintenance Log</b> .....	<b>38</b>
Daily Charge.....	12		
Block Out Time.....	12		
Refresh Charging.....	12		
<b>Abbreviations and Acronyms</b> .....	<b>13</b>		
<b>Operating Instructions</b> .....	<b>14</b>		
<b>Control Panel</b> .....	<b>15</b>		
<b>Menu Access</b> .....	<b>16</b>		

## **IMPORTANT SAFETY INSTRUCTIONS**

### **WARNING: THE SHIPPING PALLET MUST BE REMOVED FOR PROPER AND SAFE OPERATION.**

1. This manual contains important safety and operating instructions. Before using the battery charger, read all instructions, **cautions** and **warnings** on the battery charger, the battery and the product using the battery.
2. This charger has been designed to only charge lead acid batteries. Read and understand all setup and operating instructions before using the battery charger to prevent damage to the battery and to the charger.
3. **Do not** touch non-insulated parts of the output connector or the battery terminals to prevent electrical shock.
4. During charge, batteries produce hydrogen gas which can explode if ignited. Never smoke, use an open flame or create sparks in the vicinity of the battery. Ventilate well when the battery is in an enclosed space.
5. **Do not** connect or disconnect the battery plug while the charger is on. Doing so will cause arcing and burning of the connector resulting in charger damage or battery explosion.
6. Lead-acid batteries contain sulfuric acid which causes burns. **Do not** get in eyes, on skin or on clothing. In cases of contact with eyes, flush immediately with clean water for 15 minutes. Seek medical attention immediately.
7. Only factory qualified personnel can service this equipment. De-energize all AC and DC power connections before servicing the charger.
8. The charger is **not** for outdoor use.
9. Do not expose the charger to moisture. Operating **conditions** should be 32° to 113° F (0° to 45° C); 0 to 70% relative humidity.
10. Do not operate the charger if it has been dropped, received a sharp hit or otherwise damaged in any way.
11. For continued protection and to reduce the risk of fire, install chargers on a floor of non-combustible material such as stone, brick or grounded metal.

**TECHNICAL INFORMATION**

The nameplate, located on the outside of the charger, should be used to check this application before installation.

**Part Number**

This is the charger part number and specifies the characteristics of this particular charger and for this reason it is required in any discussion or correspondence regarding this unit.

**Single Display Cabinet:**

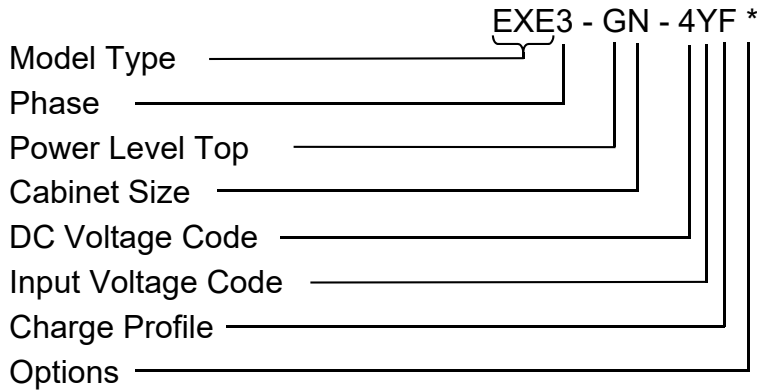

**Dual Display Cabinet:**

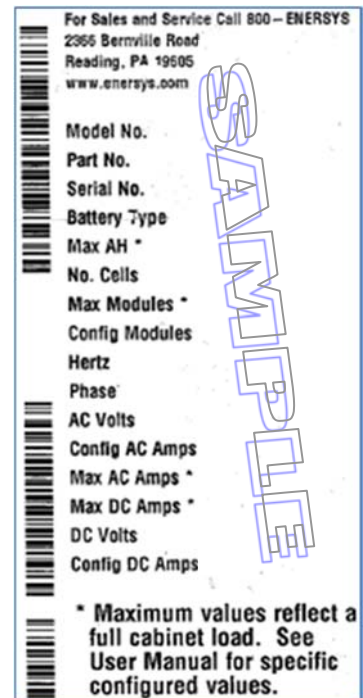
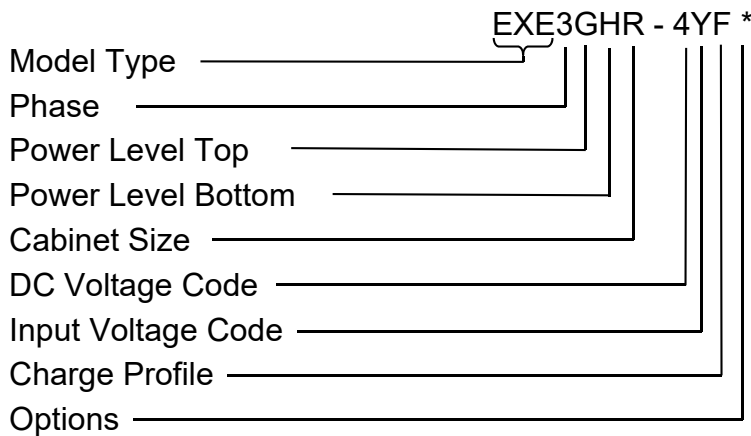

**Output Power Letter Codes**

The following table describes the letter codes to be used in charger part numbers to indicate the Output Power of the charger.

Letter Code	Output Power (kW)	Number Modules	Module Power (kW)
G	3.5	1	3.5
H	7.0	2	3.5
I	10.5	3	3.5
J	14.0	4	3.5
K	17.5	5	3.5
L	21.0	6	3.5
M	24.5	7	3.5
N	28.0	8	3.5

**Cabinet Size/Gauge Letter Codes**

The following table describes the letter codes to be used in charger part numbers to indicate the number of slots and size of the DC cables.

Letter Code	Module Positions	Standard Cable Gauge	Comments
N	4	3/0	Four slot, 3.5 kW cabinet
P	6	3/0	Six slot, 3.5 kW cabinet
R	8	3/0	Eight slot, 3.5 kW cabinet

**DC Voltage Number Codes**

The following table describes the number codes to be used in charger part numbers to indicate the DC output voltage(s) of the charger.

Number Code	Output Voltage(s)
4	24/36/48
5	72/80

**AC Line Voltage Letter Codes**

The following table describes the letter codes to be used in charger part numbers to indicate the AC line voltage(s) and AC line frequency at which the charger can be operated.

Letter Code	Voltage(s) (volts rms)	Line Frequency (Hertz)	Comments
C	600	50/60	600 VAC only
Y	480	50/60	480 VAC

\*For 480VAC chargers with line voltage of 400VAC, see specifications starting on page 34.

**Charge Profile Letter Codes**

The following table describes the letter codes to be used in charger part numbers to indicate the Charging profile of the charger.

Letter Code	Profile
C	Cold Storage
I	IONIC™
O	Opportunity
F	Fast

**Specialty Charger Options List**

Suffix	Description
C6	6 Ft of AC Cord
C10	10 Ft AC Cord
C12	12 Ft of AC Cord
L10	10 Ft of DC cable
L13	13 Ft of DC cable
L15	15 Ft of DC cable
L18	18 Ft of DC cable
L20	20 Ft of DC cable
L25	25 Ft of DC cable
L30	30 Ft of DC cable

**Serial Number**

This number indicates complete information about the specific charger. It must be supplied with the part number on any correspondence or discussion regarding this charger.

**Battery Type**

The chemical content construction of the battery this unit is designed to charge is given in this part of the nameplate. (L-A = Lead Acid)

**Max AH**

This is the maximum amp-hours capacity of this cabinet.

**No. Cells**

This is the number of battery cells this unit will charge. **This number must match exactly with any battery connected to the charger output.**

**Max Modules**

This is the maximum number of modules the cabinet can hold.

**WARNING: THE NUMBER OF MODULES MUST MATCH THE NUMBER OF "CONFIG MODULES" ON THE NAMEPLATE. DO NOT ADD MORE MODULES IN THE FIELD. CONSULT THE MANUFACTURER IF MORE MODULES ARE NEEDED.**

**Config Modules**

This is the number of modules for which this cabinet is configured.

**Hertz**

This gives the frequency in cycles per second of the AC input voltage. Under no conditions operate the charger at a different frequency or from a generator with unstable frequency.

**Phase**

Number "3" indicates a Three Phase Charger.

**AC Volts**

This is the nominal voltage for which this charger is rated. The charger will only operate on this voltage.

**Config AC Amps**

This is the AC Amps for which this charger is configured.

**Max AC Amps**

This is the maximum AC Amps for which this cabinet is rated.

**Max DC Amps**

This is the maximum output DC Amps for which this charger is rated .

**DC Volts**

This gives the nominal DC output voltage of the charger.

**Config DC Amps**

This is the output DC Amps this charger is configured for to deliver to a battery.

**CEC**

This logo is applied to chargers that are certified with the California Energy Commission in compliance with Appliance Efficiency Regulations:



**cULus**

This logo is applied to chargers that have been tested to applicable standards and requirements by Underwriters Laboratories (UL) and the Canadian Standards Association (CSA):





## INSTALLATION

**WARNING: THE SHIPPING PALLET MUST BE REMOVED FOR PROPER AND SAFE OPERATION.**

### Location

For maximum safe operation, choose a location which is free of excess moisture, dust, combustible material and corrosive fumes. Also, avoid locations where temperatures are high or where liquids will drip on the charger. Do not obstruct the ventilation openings. Follow charger warning label when mounting on or over a combustible surface. The recommended charger mounting should be at least 28 inches above the battery.

### Cabinet Mounting

The charger must be mounted on a wall, stand, shelf or floor in a vertical position. 8 bay chargers may only be mounted to the floor or an appropriate stand. The minimum distance between two chargers must be 12 inches.

The charger will be installed with four 5/16 inch bolts or with the bracket supplied. See the Mounting Dimensions section at the end of this manual for proper bolt pattern. Charger should be permanently fastened in place.

For shelf mounting, part number 159-6LA22723 is required – two per charger.

**NOTE: Ambient temperature at all levels cannot exceed 113° F (45° C).**

### Electrical Connections

To prevent failure of the charger, make sure it is connected to the correct line voltage. Follow your local and National Electric Code (NEC) in making these connections.

**WARNING: MAKE SURE THE POWER TO THE CHARGER IS OFF AND THE BATTERY IS DISCONNECTED BEFORE CONNECTING THE INPUT POWER TO THE TERMINALS OF THE CHARGER.**

### Connecting Input Power

Connect the input power to the appropriate terminals and apply appropriate torque as follow:

Phase	Power (kW)	Cabinet (Bay)	Terminals	Torque (in-lbs)
3	3.5	4 and 6	L1 L2 L3	15
3	3.5	8	L1 L2 L3	25

Connect ground wire to terminal marked with either of the two symbols below and apply same torque value per table above:



**AC Disconnect**

The user must provide suitable branch circuit protection and a disconnect method from the AC power supply to the charger to allow for safe servicing.

**Plug Polarity**

The charging cable is connected to the DC output of the charger with the positive lead marked RED. The output polarity of the charger must be strictly observed when connecting to the battery (read warning above). Improper connection may open the DC fuse and/or damage the charger.

**Grounding the Charger**

**DANGER: FAILURE TO GROUND THE CHARGER COULD LEAD TO FATAL ELECTRIC SHOCK. Follow National Electric Code for ground wire sizing.**

Connect a grounding conductor to the Ground lug provided on the horizontal support panel. This lug is marked with either of these symbols:



## **DESCRIPTION OF OPERATION**

### **General**

Express® EnCore™ chargers are microprocessor-controlled. When using the Fast Profile, the battery voltage and capacity is communicated to the charger by the Wi-iQ® device. The charging coefficient is maintained absolutely on all types of batteries. Express EnCore chargers adapt to the battery's capacity and its discharge level.

Express EnCore chargers can easily be set to charge flooded batteries used in Cold or freezer storage applications, IONIC™, Fast or Opportunity profiles. This battery charger is also designed to charge flooded lead acid storage batteries within the range of the cell and ampere-hour rating as marked on the nameplate.

### **Starting the Charge Cycle**

When a battery is connected to the charger, the control board senses the voltage and after a short delay, the charger starts charging the battery.

### **Charging Current**

Charging current is determined by the battery voltage and state of the charge condition. Charging current declines automatically as battery voltage rises during the charge. As the battery charges, the graphical display will output various charge parameters including the percentage of battery capacity.

### **AC Power Fail**

If the AC power fails with a battery connected to the charger during a charge cycle, the charger will reset and start a new charge cycle when power is restored. All charger settings as well as the time and date are preserved.

### **Series Charging**

In series charging, the voltages of both batteries add up and must match charger's nameplate DC Volts rating. The charger's amp-hour rating must be equal to each battery's ampere-hour rating. Charge cycle will not start unless both batteries are connected.

## **GLOSSARY**

### **Wi-iQ® Device**

This unit, permanently mounted on the battery, ensures that certain battery parameters can be sent to the charger for the purposes of optimizing the charge and monitoring the charging and discharging characteristics. The Wi-iQ® device is required when using the Fast Profile.

### **Charging Profile**

The charging profile defines the rate of charge current over time. The charger adapts to the battery's age and level of discharge. Controlling the overcharge coefficient, whatever the battery's discharge level, reduces the amount of electricity consumed.

### **Cold Storage Profile**

This is a charging profile that allows the configuration of the charger for use with batteries in cold storage application. The profile is an IEL (constant current, constant voltage, constant current) type with a number of user configurable parameters.

### **Equalization Charging**

Equalization charging, performed after normal charging, balances the electrolyte densities in the battery's cells.

### **Fast Profile**

This charging profile is an IEL charging profile designed to charge batteries at rates between 40-50% of their rated amp hour capacity. Requires Wi-iQ device on battery.

### **IONIC™ Profile**

The IONIC™ charging profile consistently diagnoses the battery throughout the recharge and adjusts the charging profile to effectively charge the battery. The intelligent diagnostic sampling provides more rapid optimized charging of flooded cell batteries subject to very high demands. The short current pulses stimulate gas formation in the active material, causing sulfuric acid to be distributed outside the plates and balances out differences in density, homogenizing the electrolyte across the surface of the plates.

### **Opportunity Profile**

This charging profile is used when opportunity charging is desired. It includes a start rate of up to 25% of the battery's 6-hour rated amp hour capacity and requires an equalize charge performed once a week. The weekly equalize charge can be programmed to run automatically.

### **Operation**

During opportunity charging the user should charge the battery during breaks, lunch or any available time during the work day. The Opportunity Profile allows the battery to be safely charged while it is kept in a partial state of charge between 20% and 80% of the 6-hour rated capacity during the work week. Sufficient time should be scheduled after the weekly equalize charge to check and maintain electrolyte levels and allow the battery to cool to ambient temperatures.

**Daily Charge**

When using the Opportunity Profile, the Daily Charge option can be set to add additional charging time every day if the work schedule allows. This option should be considered only when the daily work demand requires additional capacity.

**Complete Charge Time**

The time of day for a Complete charge.

**NOTE:** The factory default is daily charge disable, 6 hour Equalize, Sunday at 00 hour.

**Block Out Time**

This function inhibits the charger from charging the battery during the block out time window. If a charge cycle has started before the block out window it is inhibited during the block out window and will automatically restart the charge cycle at the end of the block out window.

**Refresh Charging**

Refresh or maintenance charging enables the battery to be maintained at maximum charge all of the time that it is connected to the charger.

**ABBREVIATIONS AND ACRONYMS**

AGM	Absorbed Glass Mat
AGV	Auto Guided Vehicle
AH	Amp-Hour
AWG	American Wire Gauge
AVAIL	Available
CEC	California Energy Commission
CFC	Termination Code
dBm	Decibel-milliwatts
DF#	Fault Number
DoD	Depth of Discharge
GND	Ground
kW	Kilowatt
L-A	Lead Acid
MAC	Media Access Control
MANU	Manual
mVpc	Millivolts Per Cell
NEMA	National Electronics Manufacturers Association
SoC	State of Charge
TH	Thermal Fault
TH-Amb	Thermal - Ambient Temperature Faults
TFT	Thin Film Transistor

## **OPERATING INSTRUCTIONS**

The *Express® EnCore™* series of chargers are compatible with batteries of 24, 36, 48, 72 and 80 volts (depending on the version supplied).

Battery recognition (voltage, capacity and state of charge) is accomplished automatically by the microprocessor. Several charging profiles are available (Cold Storage, IONIC™, Opportunity, Fast) based on the configuration chosen by the operator. Furthermore, equalization and refresh charges are integrated.

The *Express EnCore* charger includes an adapter to communicate with a Wi-iQ® device. The Wi-iQ device is an advanced battery module that measures, tracks, and stores important battery parameters such as temperature, electrolyte level, voltage and AH. This data is wirelessly transmitted to the *Express EnCore* to optimize charging, alerts the operator to battery issues, and safeguard the battery from being permanently damaged.

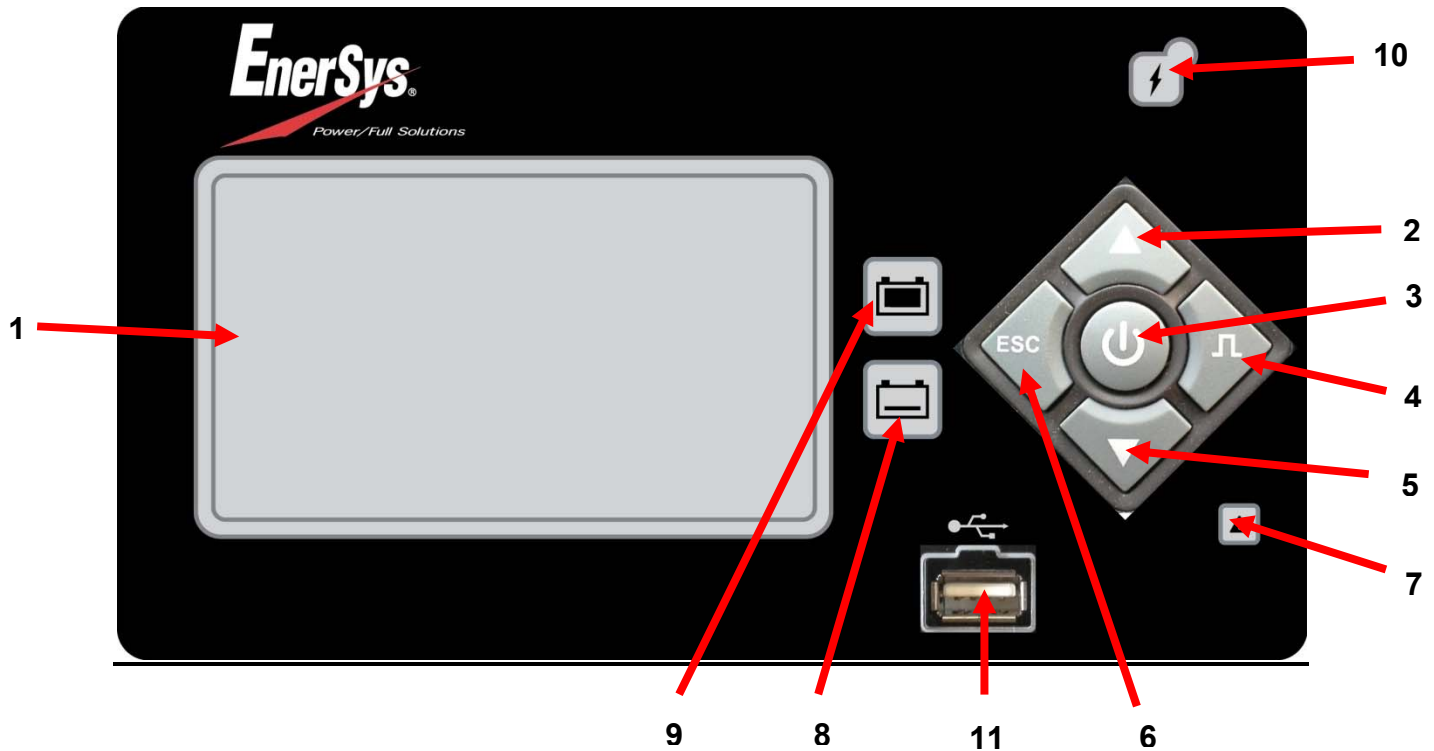
**CONTROL PANEL**

Ref	Function	Description
1	Graphical TFT display	Display charger operation info/Menus
2	Navigate UP button	Navigate menus/Change values
3	ENTER/STOP and START button	Select menu items/Enter values/Stop and restart battery charge
4	Navigate RIGHT/EQUALIZE button	Scroll right/Start equalize or desulfation
5	Navigation DOWN button	Navigate menus/Change values
6	Navigation LEFT/ESC button	Enter Main Menu/Scroll left/Exit menus
7	RED fault indicator	OFF = no fault FLASHING = ongoing fault detected ON = fault
8	YELLOW charging indicator	OFF = charger output is off ON = charging in progress
9	GREEN charge complete indicator	OFF = charger off or battery not available Flashing = cooling phase ON = battery ready and available
10	BLUE AC supply indicator	OFF = AC missing ON = AC present
11	USB port	Download memos/Upload software



## MENU ACCESS

### Main Menu Display



When the charger is idle, press and hold <ESC>, the Main Menu is then displayed. The main menu is automatically exited after 60 seconds of inactivity or can be exited voluntarily by pressing the <ESC> button.

### Main Menu

All menus are accessed from Main Menu; a detailed description of each menu is included in the next sections of this manual. The menus that require a password are not displayed until the correct password has been entered.

The menus provide access to the following functions:

- View status and memorizations (**LOGS** icon).
- Viewing of faults, alarms, etc. (**CHARGER** icon).
- USB functions (**USB** icon).
- Setting of date, language and others (**SETTINGS** icon).
- Management of password (**PASSWORD** icon).
- Exit main menu (**EXIT** icon).

## LOGS

### Memorizations Display Screen

The charger can display the details of the last 300 charge cycles.

The display here shows 3 charges have been stored in memory. MEMO 1 is the latest charge memorized. After memorizing the three-hundredth charge, the oldest record is deleted and replaced by the next oldest.

Logs	
Memo	1 04/21/14 21h 10
Memo	2 04/20/14 19h 15
	3 04/19/14 15h 25

### Displaying a Charge Cycle

Proceed as follows:

1. Select a record (MEMO x) using the ▲/▼ buttons.
2. Display the first History screen by pressing Enter.
3. Display the second History screen by pressing ▼.
4. Return to the Main Menu by pressing Esc.

The charge history is displayed; use the ▲/▼ to scroll through the parameters.

### Memorization Data

Memo	Description
<b>S/N</b>	Wi-iQ® device serial number
<b>Capacity</b>	Rated battery capacity (AH)
<b>U batt</b>	Rated battery voltage (V)
<b>Temp</b>	Battery temperature at start of charge (F)
<b>Techno</b>	Battery technology
<b>Profile</b>	Selected profile
<b>% init</b>	State of charge at start of charge (%)
<b>U start</b>	Battery voltage at start of charge (Vpc)
<b>U end</b>	Battery voltage at end of charge (Vpc)
<b>Warning</b>	Wi-iQ® device warnings

Memo	Description
<b>I end</b>	Current at end of charge
<b>Temp end</b>	Battery temperature at end of charge (F)
<b>Chg Time</b>	Time of the charge cycle (minutes)
<b>AH</b>	Amp-hours returned during charge cycle
<b>kWh</b>	Kilowatt-hours returned during charge cycle
<b>Status</b>	Partial or Complete
<b>Default</b>	Fault codes
<b>SoC</b>	Start of charge date and time
<b>DBa</b>	Battery disconnect date and time
<b>CFC</b>	Termination code (for service tech)

## STATUS

This menu displays the status of the charger's internal counters (number of normal and partial charges, fault code, etc.).

### Status Screen

Logs		
<u>Status</u>	CHARGE	0
	COMPLETE	0
	PARTIAL	0
	DF1	0
	DF2	0
	DF3	0
	DF4	0
	DF5	0

Status	Description
<b>Charge</b>	Total number of charges - corresponds to the total of normally terminated charges and charges terminated with or by faults
<b>Complete</b>	Number of charges normally terminated
<b>Partial</b>	Number of charges terminated abnormally
<b>TH</b>	Number of charger temperature faults
<b>DF1 etc.</b>	Number of faults recorded by the charger (see Fault Codes)

## CHARGER

This menu displays information on the chargers configuration and output current of the charger and the power modules.

### Information

This screen displays the following information on the charger's configuration.

### Charger Information Display

<b>Charger</b>	
<b>Informations</b>	
Profile: FAST	Delay Charge: 0 h 0 m
T °: 68 °F	Autostart: On
Capacity: Auto	
Max Current: 105 A	
Floating: Off	
Cable: 13 ft	
Equal: 6 h, 5 A	

Information	Description
<b>Profile</b>	Selected Charging Profile
<b>Temperature</b>	Programmed or Wi-iQ® device temperature
<b>Capacity</b>	Automatic or Manual
<b>Max. Current</b>	Maximum Current of Charger
<b>Floating</b>	ON/OFF
<b>Cable</b>	Length of DC Cable
<b>Equal</b>	Equalize Time and Current
<b>Delay Charge</b>	In Hours and Minutes
<b>Auto Start</b>	ON/OFF

## **USB**

This menu provides access to the USB function to update software.

### **Update Software**

Updates charger's internal software. The software is provided by EnerSys®.

## **SETTINGS**

### **Parameters:**

#### **Date/Time**

Sets date and time of the charger. The clock has a battery backup which will preserve the time when power to the charger is off.

#### **Language**

Selects the language displayed in the menus.

#### **Region**

Selects the format for date, metric (EU) or imperial (US) units for temperature, length and cable gauge.

#### **Display**

Set screen saver function and display Themes.

##### **Screen Saver**







Enables or Disables the screen saver function.

##### **Delay Saving**

Set the time the screen stays illuminated. The delay time is adjustable in minutes up to one hour and 59 minutes.

**Themes**

Themes A and B are two different ways that information is displayed throughout the charge cycle as seen in table below. Theme A is selected by default and will be used in this manual.

FUNCTION	Theme A	Theme B
IDLE Screen		
	<p>Battery Disconnects while Charging. Alternates every two seconds with <b>CONNECT BATTERY</b>.</p>	
	<p>Charger paused while battery connected</p>	
CHARGING Screen		

AVAIL Screen		
EQUALIZATION Screen		

### Daylight Saving

Enables or disables automatic clock adjustment for daylight savings time. When enabled, time will move ahead one hour at 02:00 on the second Sunday in March and will move back one hour at 02:00 on the first Sunday of November. The charger must be powered up at the time of the change for it to take effect.

### PASSWORD

This is where the password is entered to gain access to service level menus by authorized EnerSys® service personnel.

## CHARGING THE BATTERY

At this point, the charger should have been set up by a qualified service person. Charging can only begin when a battery of the proper type, capacity and voltage is connected to the charger.

With the charger in wait mode (no battery connected) and without pressing the Stop/Start button, the display will show the following information:

### Charger Idle Display

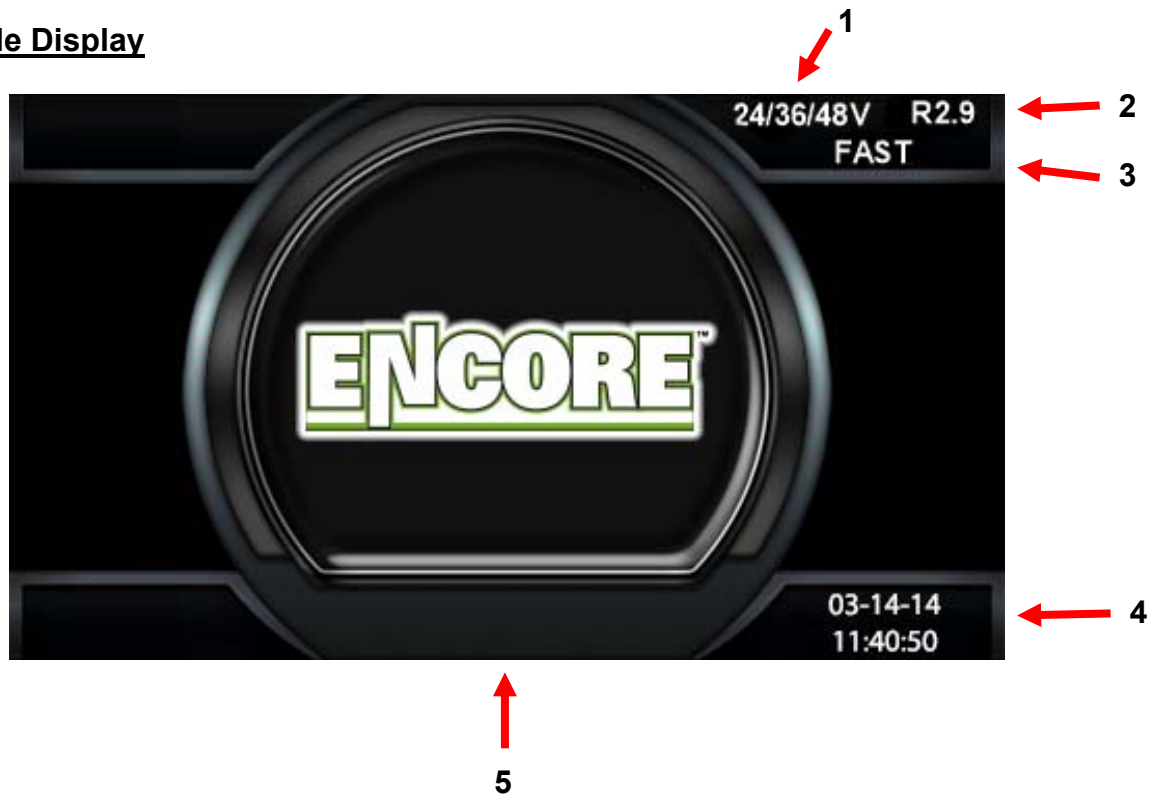

Ref	Description
1	Charger DC Voltage
2	Firmware Version
3	Selected Charge Profile
4	System Time and Date
5	Connect Battery



### **Starting a Charge Cycle**

The charger will start automatically when a battery is connected or if Stop/Start button is pushed if the battery is already connected.

### **Delayed Start**

If the charger was programmed for delayed start, charging will begin following that delay. When the battery is plugged in to the charger, the display shows the time remaining before the programmed charging starts.

### **Count Down Display**



#### ***Without a Wi-iQ® Device***

If the Wi-iQ® device adapter is not enabled or no Wi-iQ devices are in range, effective charging starts after the programmed delay. The charger uses Profile, Capacity and Temperature settings programmed in the Configuration menu.\*

#### ***With a Wi-iQ® Device***

If a Wi-iQ® device adapter is present and one or more Wi-iQ device is in range, the charger will turn on and apply current to the battery. The display will show "SCAN" followed by "IQLINK". This routine determines which Wi-iQ device in range the battery charger is connected to. Once the charger makes the determination it downloads data from Wi-iQ device, displays the battery S/N, updates the profile capacity, and temperature for charging, and starts the main charge.

\*Not applicable to Fast Charge Profile.

## Charger Display

A few moments into the effective charge, the display will begin alternating between the following charging information:

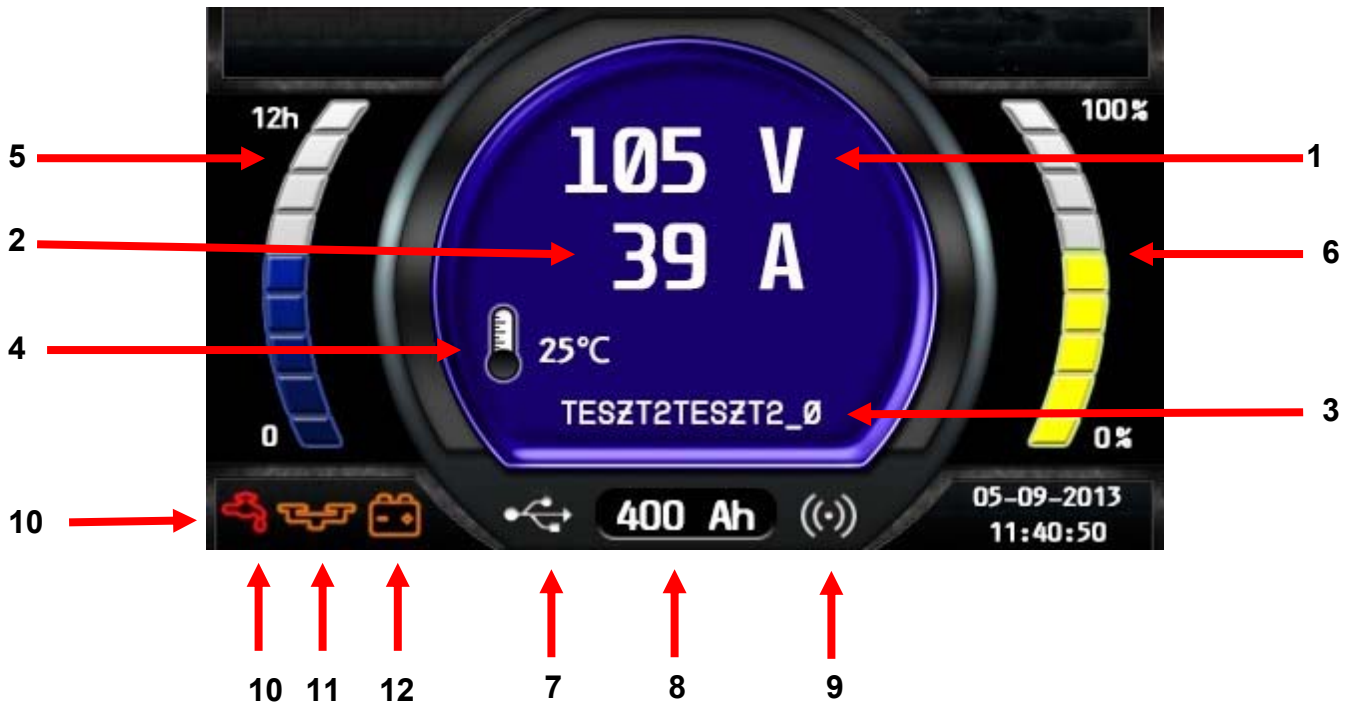

Ref	Description
1	Charge Voltage (total V and V/c)
2	Charge Current
3	Battery S/N from Wi-iQ® Device
4	Battery Temperature, Alternates with AH Returned
5	Charge Time
6	Percent of Charge
7	USB Connection
8	Battery Capacity
9	Wi-iQ Device Link
10	Wi-iQ Device Warning: Low Water
11	Wi-iQ Device Warning: Weak Cell
12	Wi-iQ Device Warning: Hot Battery

## End of Charge Display



### End of Charge without Equalization

The green complete LED comes on after proper end of charge. The green complete LED is on and the display shows AVAIL. The display alternates between:

- Total charging time.
- Amp-Hours restored to the battery.

Any other lit LED indicates a problem during charging. Please refer to paragraph *Control Panel* for more information.

If the battery remains plugged in and refresh charge has been enabled, refreshes will occur to maintain an optimal charge.

The battery is now ready for use. Push the ON/OFF button before unplugging the battery.

### End of Charge with Equalization

An Equalize charge can be started manually or automatically.

#### **Manual Equalization Start**

1. At the end of charge (green LED on or flashing), press on the <EQUALIZE> button. The equalize button can also be pressed any time during the charge and an equalize charge will be started after charging is complete.

**NOTE:** When an Equalize charge is manually started, the output current will be set to the value saved in the charger configuration.

2. The start of the equalization charge is indicated by the symbol . During the equalization charge, the charger displays the output current and alternates: the battery voltage, voltage per cell and remaining time.
3. The battery will be available when the green LED comes back on and the display shows AVAIL.
4. The battery is now ready for use. If the battery remains plugged in and refresh charge has been enabled, refreshes will occur to maintain an optimal charge. Push the ON/OFF button before unplugging the battery.

### **Automatic Equalization Start**

If an equalization day has been programmed in Charger configurations the equalization charge will start automatically on the programmed day of the week after charging is complete.



**NOTE:** The factory default FAST profile's Equalize is 12 hours on Sunday at 00 hour.

The battery will be available when the green LED comes back on and the display shows AVAIL. The battery is now ready for use. If the battery remains plugged in and refresh charge has been enabled, refreshes will occur to maintain an optimal charge. Push the ON/OFF button before unplugging the battery.

**FAULT CODES****Fault Display**

In case of a fault, one of the corresponding fault codes listed below will appear on the display. If it is a critical fault, charging will stop and the red Fault LED will be illuminated.

<b>Fault</b>	<b>Critical</b>	<b>Cause</b>	<b>Solution</b>
<b>DF1</b>	Yes	Low output current	Check input voltage and fuses.
<b>DF2</b>	Yes	Output fault	Check for proper battery connection (reversed polarity). Check output fuse.
<b>DF3</b>	Yes	Incorrect battery	Battery voltage too high (>2.4 Vpc) or too low (<1.6 Vpc). Use proper charger for battery.
<b>DF4</b>	No	The battery has been discharged more than 80% of its capacity.	Prevent future over discharging of battery. Battery charge gauges and lift interrupts may need calibration.
<b>DF5</b>	No	Battery requires inspection	Non critical fault. Check battery cables for condition and size, check for loose connections, check for defective cells. Check for defective cells.
<b>DF7</b>	No	Inspect battery	Non critical fault. This will cause the charge to terminate early. Battery may require service. Check the battery (Temperature, Specific gravity...). Check the battery condition of use. Check the configuration in the menu (charge cables parameters).

Fault	Critical	Cause	Solution
TH or TH-Amb	Yes	Charger overheating	Check that fans are working. Verify that ambient temperature is not too high – above 113° F (45° C). Inspect to see if charger ventilation is obstructed or impaired.
	No	Low battery electrolyte	Check battery electrolyte level.
WATER LEVEL	Yes	Critical battery electrolyte	Check battery electrolyte level.
BAT TEMP	Yes	Battery temperature reached maximum level.	Allow battery to cool down.
MOD TH	No	Alternating with charge parameters – one or more module in thermal fault – the charge process continues – the fault module(s) is(are) displayed + red led flashing.	Check that the fan(s) is (are) working correctly and/or that the ambient temperature is not too high or whether there is poor natural ventilation to the charger. If all modules are in thermal fault a TH fault will follow.
DFMOD	No	Alternating with charge parameters – one or more module in DF1 fault – the charge process continues – the fault module(s) is (are) displayed + red led flashing.	Check power modules. If all modules in DF1 fault a DF1 error will follow.
DEF ID	Yes	Blocking fault – one or more modules are not compatible with the charger configuration (for example 24 V charger with one 48 V module). This can happen if the user replaces one module with another one with a different voltage setting.	Use correct module(s).
	No	Battery balance fault	Check battery cell voltages.

**MAINTENANCE AND SERVICE**

**WARNING: THERE ARE DANGEROUS VOLTAGES WITHIN THE BATTERY CHARGER CABINET. ONLY A QUALIFIED PERSON SHOULD ATTEMPT TO ADJUST OR SERVICE THIS BATTERY CHARGER.**

The charger requires minimal maintenance. Connections and terminals should be kept clean and tight. The unit (especially the heatsink) should be periodically cleaned with an air hose to prevent any excessive dirt build up on components. Care should be taken not to bump or move any adjustments during cleaning. Make sure that both the AC lines and the battery are disconnected before cleaning. The frequency of this type of maintenance depends on the environment in which this unit is installed.

**For service, contact your sales representative or call:**

**1-800-ENERSYS (USA)  
1-800-363-7797**

### MOUNTING DIMENSIONS

#### 3.5 kW 4 Bay Cabinet Mounting Dimensions

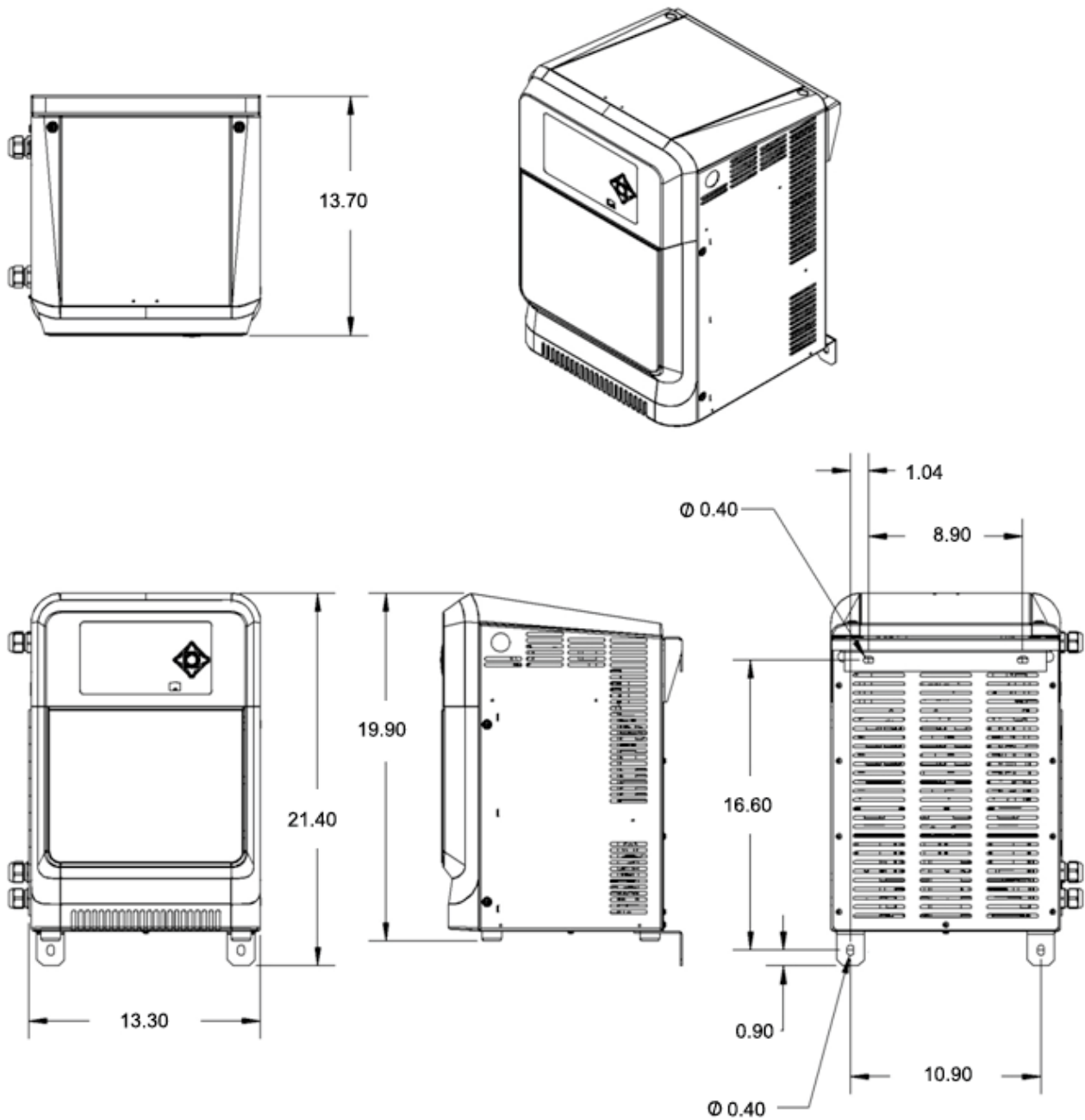

Dimensions shown are in inches.



### 3.5 kW 6 Bay Cabinet Mounting Dimensions

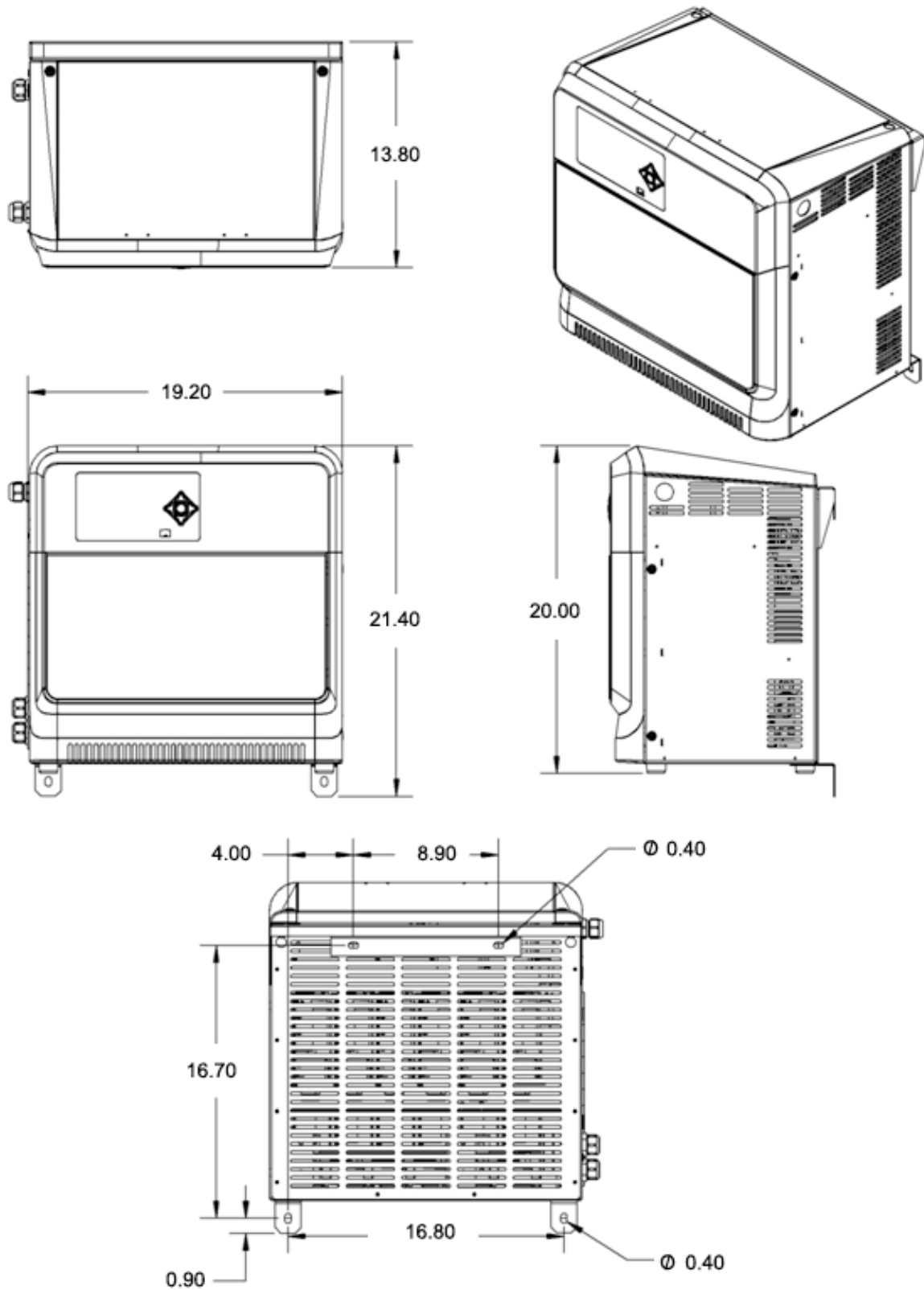

Dimensions shown are in inches.

### 3.5 kW 8 Bay Cabinet Mounting Dimensions

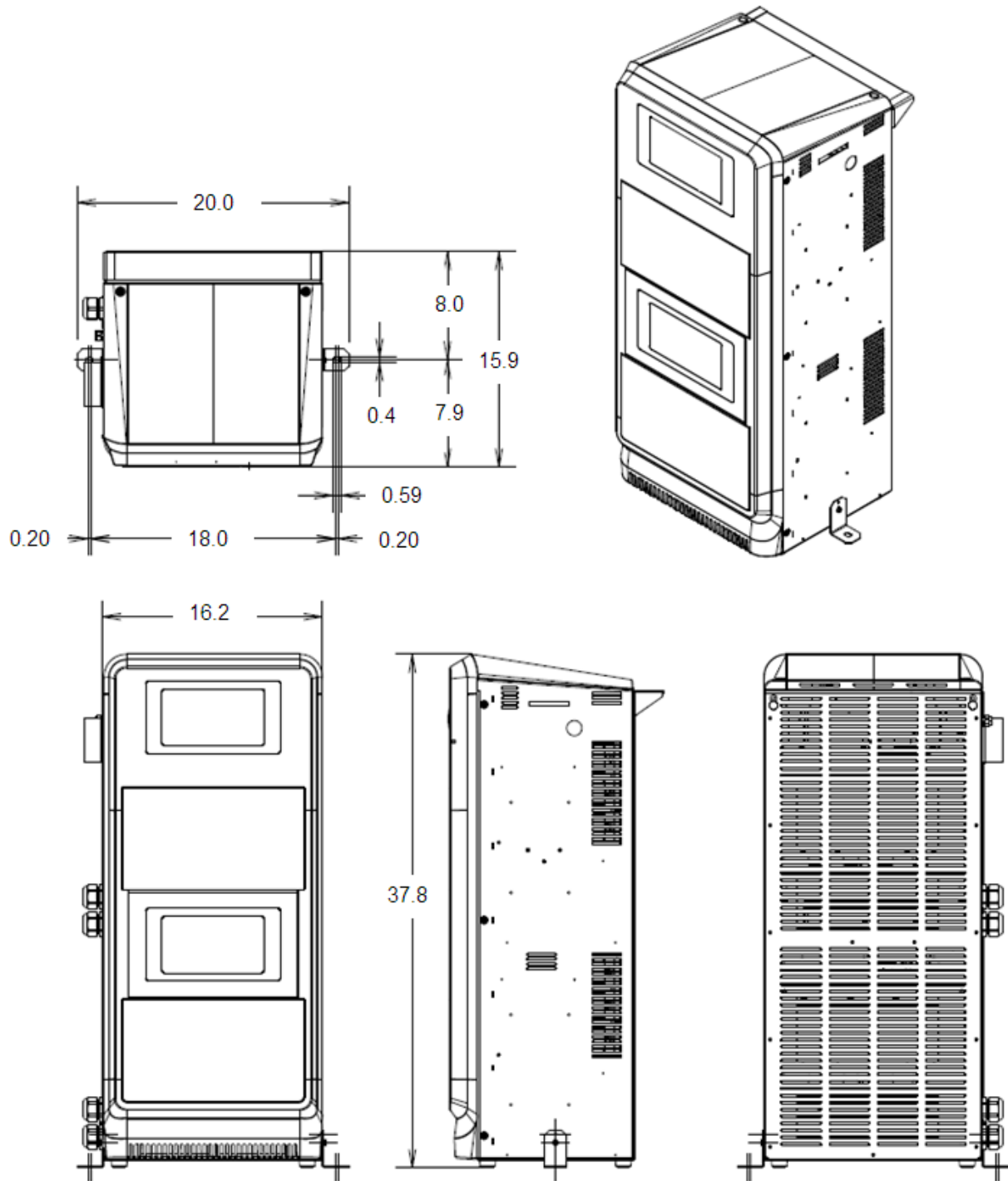

Dimensions shown are in inches

**TECHNICAL SPECIFICATIONS****3.5 kW Standard Technical Specifications**

Part Number	AC Input					DC Output			Max 8 Hour Capacity (Ah)	Charger Cable AWG
	Voltage	Max Amps	Phase	Min Cord AWG	NEMA Plug	Cells	kW	Max Current (A)		
EXE3-GN-4YF	480	4.8	3	14	L16-20	12/18/24	3.5	80/80/60	200/200/150	3/0
EXE3-HN-4YF	480	9.6	3	14	L16-20	12/18/24	7	160/160/120	400/400/300	3/0
EXE3-IN-4YF	480	14.4	3	14	L16-20	12/18/24	10.5	240/240/180	600/600/450	3/0
EXE3-JN-4YF	480	19.2	3	10	L16-30	12/18/24	14	320/320/240	800/800/600	3/0
EXE3-IP-4YF	480	14.4	3	14	L16-20	12/18/24	10.5	240/240/180	600/600/450	3/0
EXE3-JP-4YF	480	19.2	3	10	L16-30	12/18/24	14	320/320/240	800/800/600	3/0
EXE3-KP-4YF	480	24	3	10	L16-30	12/18/24	17.5	320/320/300	800/800/750	3/0
EXE3-LP-4YF	480	28.8	3	8	CS8165C*	12/18/24	21	320/320/320	800/800/800	3/0
EXE3-KP-4YFDC	480	24	3	10	L16-30	12/18/24	17.5	400/400/300	1000/1000/750	Dual 3/0
EXE3-LP-4YFDC	480	28.8	3	8	CS8165C*	12/18/24	21	480/480/360	1200/1200/900	Dual 3/0
EXE3-MR-4YFDC	480	33.6	3	8	CS8165C*	12/18/24	24.5	560/560/420	1400/1400/1050	Dual 3/0
EXE3-NR-4YFDC	480	38.4	3	6	HW**	12/18/24	28	640/640/480	1600/1600/1200	Dual 3/0
EXE3GGR-4YF	480	9.6	3	14	L16-20	12/18/24	3.5 3.5	80/80/60 80/80/60	200/200/150 200/200/150	3/0 3/0
EXE3GHR-4YF	480	14.4	3	14	L16-20	12/18/24	3.5 7.0	80/80/60 160/160/120	200/200/150 400/400/300	3/0 3/0
EXE3HHR-4YF	480	19.2	3	10	L16-30	12/18/24	7.0 7.0	160/160/120 160/160/120	400/400/300 400/400/300	3/0 3/0
EXE3HIR-4YF	480	24	3	10	L16-30	12/18/24	7.0 10.5	160/160/120 240/240/180	400/400/300 600/600/450	3/0 3/0
EXE3IIR-4YF	480	28.8	3	8	CS8165C*	12/18/24	10.5 10.5	240/240/180 240/240/180	600/600/450 600/600/450	3/0 3/0
EXE3IJR-4YF	480	33.6	3	8	CS8165C*	12/18/24	10.5 14.0	240/240/180 320/320/240	600/600/450 800/800/600	3/0 3/0

\* Non NEMA plug \*\* Hard-Wired only

Part Number	AC Input					DC Output			Max 8 Hour Capacity (Ah)	Charger Cable AWG
	Voltage	Max Amps	Phase	Min Cord AWG	NEMA Plug	Cells	kW	Max Current (A)		
EXE3JJR-4YF	480	38.4	3	6	HW**	12/18/24	14.0 14.0	320/320/240 320/320/240	800/800/600 800/800/600	3/0 3/0
EXE3-GN-5YF	480	4.8	3	14	L16-20	36/40	3.5	40/36	100/90	3/0
EXE3-HN-5YF	480	9.6	3	14	L16-20	36/40	7	80/72	200/180	3/0
EXE3-IN-5YF	480	14.4	3	14	L16-20	36/40	10.5	120/108	300/270	3/0
EXE3-JN-5YF	480	19.2	3	10	L16-30	36/40	14	160/144	400/360	3/0
EXE3-IP-5YF	480	14.4	3	14	L16-20	36/40	10.5	120/108	300/270	3/0
EXE3-JP-5YF	480	19.2	3	10	L16-30	36/40	14	160/144	400/360	3/0
EXE3-KP-5YF	480	24	3	10	L16-30	36/40	17.5	200/180	500/450	3/0
EXE3-LP-5YF	480	28.8	3	8	CS8165C*	36/40	21	240/216	600/540	3/0
EXE3-MR-5YF	480	33.6	3	8	CS8165C*	36/40	24.5	280/252	700/630	3/0
EXE3-NR-5YF	480	38.4	3	6	HW**	36/40	28	320/288	800/720	3/0
EXE3GGR-5YF	480	9.6	3	14	L16-20	12/18/24	3.5 3.5	40/36 40/36	100/90 100/90	3/0 3/0
EXE3GHR-5YF	480	14.4	3	14	L16-20	12/18/24	3.5 7.0	40/36 80/72	100/90 200/180	3/0 3/0
EXE3HHR-5YF	480	19.2	3	10	L16-30	12/18/24	7.0 7.0	80/72 80/72	200/180 200/180	3/0 3/0
EXE3HIR-5YF	480	24	3	10	L16-30	12/18/24	7.0 10.5	80/72 120/108	200/180 300/270	3/0 3/0
EXE3IIR-5YF	480	28.8	3	8	CS8165C*	12/18/24	10.5 10.5	120/108 120/108	300/270 300/270	3/0 3/0
EXE3IJR-5YF	480	33.6	3	8	CS8165C*	12/18/24	10.5 14.0	120/108 160/144	300/270 400/360	3/0 3/0
EXE3JJR-5YF	480	38.4	3	6	HW**	12/18/24	14.0 14.0	160/144 160/144	400/360 400/360	3/0 3/0
EXE3-GN-4CF	600	3.8	3	10	L17-30	12/18/24	3.5	80/80/60	200/200/150	3/0
EXE3-HN-4CF	600	7.6	3	10	L17-30	12/18/24	7	160/160/120	400/400/300	3/0
EXE3-IN-4CF	600	11.4	3	10	L17-30	12/18/24	10.5	240/240/180	600/600/450	3/0
EXE3-JN-4CF	600	15.2	3	12	L17-30	12/18/24	14	320/320/240	800/800/600	3/0

\* Non NEMA plug \*\* Hard-Wired only

Part Number	AC Input					DC Output			Max 8 Hour Capacity (Ah)	Charger Cable AWG
	Voltage	Max Amps	Phase	Min Cord AWG	NEMA Plug	Cells	kW	Max Current (A)		
EXE3-IP-4CF	600	11.4	3	10	L17-30	12/18/24	10.5	240/240/180	600/600/450	3/0
EXE3-JP-4CF	600	15.2	3	12	L17-30	12/18/24	14	320/320/240	800/800/600	3/0
EXE3-KP-4CF	600	19.0	3	10	L17-30	12/18/24	17.5	320/320/300	800/800/750	3/0
EXE3-LP-4CF	600	22.8	3	10	L17-30	12/18/24	21	320/320/320	800/800/800	3/0
EXE3-KP-4CFDC	600	19.0	3	10	L17-30	12/18/24	17.5	400/400/300	1000/1000/750	Dual 3/0
EXE3-LP-4CFDC	600	22.8	3	10	L17-30	12/18/24	21	480/480/360	1200/1200/900	Dual 3/0
EXE3-MR-4YFDC	600	26.6	3	8	3765C*	12/18/24	24.5	560/560/420	1400/1400/1050	Dual 3/0
EXE3-NR-4YFDC	600	30.4	3	8	3765C*	12/18/24	28	640/640/480	1600/1600/1200	Dual 3/0
EXE3GGR-4CF	600	7.6	3	14	L17-30	12/18/24	3.5 3.5	80/80/60 80/80/60	200/200/150 200/200/150	3/0 3/0
EXE3GHR-4CF	600	11.4	3	14	L17-30	12/18/24	3.5 7.0	80/80/60 160/160/120	200/200/150 400/400/300	3/0 3/0
EXE3HHR-4CF	600	15.2	3	12	L17-30	12/18/24	7.0 7.0	160/160/120 160/160/120	400/400/300 400/400/300	3/0 3/0
EXE3HIR-4CF	600	19	3	10	L17-30	12/18/24	7.0 10.5	160/160/120 240/240/180	400/400/300 600/600/450	3/0 3/0
EXE3IIR-4CF	600	22.8	3	10	L17-30	12/18/24	10.5 10.5	240/240/180 240/240/180	600/600/450 600/600/450	3/0 3/0
EXE3IJR-4CF	600	26.6	3	8	3765C*	12/18/24	10.5 14.0	240/240/180 320/320/240	600/600/450 800/800/600	3/0 3/0
EXE3JJR-4CF	600	30.4	3	8	3765C*	12/18/24	14.0 14.0	320/320/240 320/320/240	800/800/600 800/800/600	3/0 3/0
EXE3-GN-5CF	600	3.8	3	10	L17-30	36/40	3.5	40/36	100/90	3/0
EXE3-HN-5CF	600	7.6	3	10	L17-30	36/40	7	80/72	200/180	3/0
EXE3-IN-5CF	600	11.4	3	10	L17-30	36/40	10.5	120/108	300/270	3/0
EXE3-JN-5CF	600	15.2	3	12	L17-30	36/40	14	160/144	400/360	3/0
EXE3-IP-5CF	600	11.4	3	10	L17-30	36/40	10.5	120/108	300/270	3/0
EXE3-JP-5CF	600	15.2	3	12	L17-30	36/40	14	160/144	400/360	3/0
EXE3-KP-5CF	600	19.0	3	10	L17-30	36/40	17.5	200/180	500/450	3/0
EXE3-LP-5CF	600	22.8	3	10	L17-30	36/40	21	240/216	600/540	3/0

\* Non NEMA plug

Part Number	AC Input					DC Output			Max 8 Hour Capacity (Ah)	Charger Cable AWG
	Voltage	Max Amps	Phase	Min Cord AWG	NEMA Plug	Cells	kW	Max Current (A)		
EXE3-MR-5CF	600	26.6	3	8	3765C*	36/40	24.5	280/252	700/630	3/0
EXE3-NR-5CF	600	30.4	3	8	3765C*	36/40	28	320/288	800/720	3/0
EXE3GGR-5CF	600	7.6	3	14	L17-30	36/40	3.5 3.5	40/36 40/36	100/90 100/90	3/0 3/0
EXE3GHR-5CF	600	11.4	3	14	L17-30	36/40	3.5 7.0	40/36 80/72	100/90 200/180	3/0 3/0
EXE3HHR-5CF	600	15.2	3	12	L17-30	36/40	7.0 7.0	80/72 80/72	200/180 200/180	3/0 3/0
EXE3HIR-5CF	600	19	3	10	L17-30	36/40	7.0 10.5	80/72 120/108	200/180 300/270	3/0 3/0
EXE3IIR-5CF	600	22.8	3	10	L17-30	36/40	10.5 10.5	120/108 120/108	300/270 300/270	3/0 3/0
EXE3IJR-5CF	600	26.6	3	8	3765C*	36/40	10.5 14.0	120/108 160/144	300/270 400/360	3/0 3/0
EXE3JJR-5CF	600	30.4	3	8	3765C*	36/40	14.0 14.0	160/144 160/144	400/360 400/360	3/0 3/0

\* Non NEMA plug

**MAINTENANCE LOG**

1. Modifications to Factory Settings

Date	Variable	Change	Service Technician

2. Service

Date	Description	Service Technician



ENERSYS WORLD HEADQUARTERS  
2366 Bernville Road  
Reading, PA 19605  
+1-800-EnerSys  
Fax: +1-610-372-8613  
[www.enersys.com](http://www.enersys.com)

ENERSYS CANADA INC.  
61 Parr Boulevard Unit 3  
Bolton, Ontario  
Canada L7E 4E3  
+1-800-363-4877  
Fax: +1-905-951-4441

ENERSYS DE MEXICO  
Ave Lopez Mateos #4210  
Colonia Casa Blanca • C.P. 66475 San Nicolas  
de los Graza, N.L. Mexico  
+52-818-329-6400  
Fax: +52-818-329-6489