

# Instructions for use Fiamm Motive Power Water Less® / Water Less® 20









# ENGLISH

## Traction batteries with positive tubular plates type PzM / PzMB

### Rating Data

1. Nominal capacity C <sub>5</sub> :	See type plate
2. Nominal voltage:	2.0 V x No of cells
3. Discharge current	C <sub>5</sub> /5h
4. Nominal S.G. of electrolyte*: Type PzM / PzMB:	1.29 kg/l
5. Rated temperature:	30°C
6. Nominal electrolyte level:	up to electrolyte level mark "max."

\* Will be reached within the first 10 cycles.

	<ul style="list-style-type: none"> <li>Pay attention to the operation instruction and fix them close to the battery.</li> <li>Work on batteries to be carried out by skilled personnel only!</li> </ul>		<ul style="list-style-type: none"> <li>Risk of explosion and fire, avoid short circuits!</li> <li>Caution: Metal parts of the battery are always live. Do not place tools or other metal objects on the battery!</li> </ul>
	<ul style="list-style-type: none"> <li>Use protective glasses and clothes when working on batteries. Pay attention to the accident prevention rules as well as EN 62485-3 and EN 50110-1.</li> </ul>		<ul style="list-style-type: none"> <li>Electrolyte is highly corrosive.</li> </ul>
	<ul style="list-style-type: none"> <li>No smoking!</li> <li>Do not expose batteries to naked flames, glowing embers or sparks, as it may cause the battery to explode.</li> </ul>		<ul style="list-style-type: none"> <li>Batteries and cells are heavy.</li> <li>Ensure secure installation! Use only suitable handling equipment e.g. lifting gear in accordance with VDI 3616.</li> </ul>
	<ul style="list-style-type: none"> <li>Acid splashes in the eyes or on the skin must be washed with water. In case of accident consult a doctor immediately!</li> <li>Clothing contaminated by acid should be washed in water.</li> </ul>		<ul style="list-style-type: none"> <li>Dangerous electrical voltage!</li> </ul>
<p>Ignoring the operation instructions, repair with non-original parts or using additives for the electrolyte will render the warranty void.</p>			

### 1. Commissioning filled and charged batteries

For commissioning of unfilled batteries see separate instructions! The battery should be inspected to ensure it is in perfect physical condition. The charger cables must be connected to ensure a good contact, taking care that the polarity is correct. Otherwise battery, vehicle or charger could be damaged.

For the assembly of harness cables or in case of the replacement of a connector the following torque must be applied:

M 10 perfect connector

25 ± 2 Nm

In case the interval between delivery (see manufacturing date on type plate) and commissioning is longer than 8 weeks or the electrolyte level sensor is indicating low electrolyte level (see table point 3.1.1), the electrolyte level has to be checked. If the battery is equipped with a single point water topping up system (optional), for the removal of the BFS plugs only the appropriate tool must be used. Otherwise the floats of plugs may be permanently damaged, which can cause overflow of the cells. If the electrolyte level is below the top of the separator, it must first be topped up to this height with purified water (IEC 62877-1 : 2016). Then the battery can be charged as in item 2.2.

The electrolyte should be topped up to the specified level with purified water. Fiamm Motive Power Water Less® / Water Less® 20 batteries are fitted with an electrolyte level indicator.

### 2. Operation

EN 62485-3 "Traction batteries for industrial trucks" is the standard which applies to the operation traction batteries in industrial trucks.

### 2.1 Discharging

Be sure that all ventilation holes are not sealed or covered. Electrical connections (e.g. plugs) must only be made or broken in the open circuit condition. To achieve the optimum life for the battery, operating discharges of more than 80% of the rated capacity should be avoided (deep discharge). This corresponds to an electrolyte specific gravity of 1.14 kg/l at 30°C at the end of the discharge. Discharged batteries must be recharged immediately and must not be left discharged. This also applies to partially discharged batteries.

### 2.2 Charging

Only direct current must be used for charging. All charging procedures in accordance with EN 41773-1 and EN 41774 are permitted. Only connect the battery assigned to a charger, suitable for the size of battery, in order to avoid overloading of the electric cables and contacts, unacceptable gassing and the escape of electrolyte from the cells. In the gassing stage the current limits given in EN 62485-3 must not be exceeded. If the charger was not purchased together with the battery it is best to have its suitability checked by the manufacturers service department. When charging, proper provision must be made for venting of the charging gases. Doors, battery container lids and covers of battery compartments must be opened or removed. During the charge the battery must be removed from the closed battery compartment on the truck. The ventilation must comply to EN 62485-3 standard. The vent plugs should stay on the cells and remain closed. With the charger switched off connect up the battery, ensuring that the polarity is correct. (positive to positive, negative to negative). Now switch on the charger. When charging the temperature of the electrolyte rises by about 10°C, so charging should only begin if the electrolyte temperature is below 45°C.

The electrolyte temperature of batteries should be at least +10°C before charging otherwise a full charge will not be achieved. A charge is finished when the specific gravity of the electrolyte and the battery voltage have remained constant for two hours.

### 2.3 Equalising charge

Equalising charges are used to safeguard the life of the battery and to maintain its capacity. They are necessary after deep discharges, repeated incomplete recharges and charges to an IU characteristic curve. Equalising charges are carried out following normal charging. The charging current must not exceed 5 A/100 Ah of rated capacity (end of charge - see point 2.2). **Watch the temperature!**

### 2.4 Temperature

An electrolyte temperature of 30°C is specified as the rated temperature. Higher temperatures shorten the life of the battery, lower temperatures reduce the capacity available. 55°C is the upper temperature limit and is not acceptable as an operating temperature.

### 2.5 Electrolyte

The rated specific gravity (S. G.) of the electrolyte is related to a temperature of 30°C and the nominal electrolyte level in the cell in fully charged condition.

Higher temperatures reduce the specified gravity of the electrolyte, lower temperatures increase it. The temperature correction factor is -0.0007 kg/l per °C, e.g. an electrolyte specific gravity of 1.28 kg/l at 45°C corresponds to an S.G. of 1.29 kg/l at 30°C. The electrolyte must conform to the purity regulations in IEC 62877-2 : 2016.

## 3. Maintenance



### 3.1 Daily

Charge the battery after every discharge. Fiamm Motive Power Water Less®/Water Less® 20: towards the end of charge the electrolyte level sensor should be checked (see tables 3.1.1) and if necessary topped up to the specified level with purified water (according IEC 62877-1 : 2016). **NO WATERING IN THE FIRST 10 CYCLES.**

#### 3.1.1 Filling level sensors

The LED of the electrolyte level sensor should be observed daily.

A

BLINKY-ELECTROLYTE LEVEL INDICATOR	
TYPE	2 - 3 positive plates of PzM
 <p>white housing</p>	<p>Green = electrolyte level is OK No indication = water topping up should be carried out</p>
TYPE	4 - 11 positive plates of PzM
 <p>blue housing</p>	<p>Green flashing = electrolyte level is OK Green/red flashing = safety cycle limit countdown Red flashing = water topping up should be carried out</p>

B

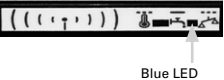
Wi-iQ®-ELECTROLYTE LEVEL INDICATOR	
TYPE	4 and more positive plates
 <p>Blue LED</p>	<p>Flashing = electrolyte level is OK Light is constantly on = Electrolyte level is low - please top up</p>

**Do not top up the cells even when electrolyte level sensor shows a red blinking LED during first 10 cycles.**

The electrolyte level checking has to be performed after low level detection of the sensor or after water topping up interval (see "water refilling system" point 2.1) Check the electrolyte level (visual inspection by opening the vent plug or by the position of the float indicator of the Aquallevel plug) and top-up with demineralised water at the end of the charge. Since the display always refers to a selected reference cell, please also pay attention to the additional instructions under "3.3 Monthly Maintenance."

### 3.2 Weekly

Visual inspection after recharging for signs of dirt and mechanical damage to all component parts of the battery, pay particular attention to the battery charging plugs and cables. By special applications with charge with a IU characteristic curve an equalising charge must be carried out (see point 2.3; see point 7. Water topping up interval).

### 3.3 Monthly

At the end of the charge the voltages of all cells should be measured with the charger switched on, and recorded. After charging has been completed, the electrolyte density, electrolyte temperature as well as the filling level (when filling level sensors are used) of all cells are to be measured and recorded. If significant changes from earlier measurements or differences between the cells are found further testing and maintenance by the service department should be requested. This should be done following a complete charge and minimum of 2 hours rest time. Measure and record:

- total voltage
  - voltage per cell
  - if the voltage readings are irregular, also check the S.G. of each cell
- (see point 7. Water topping up interval)

### 3.4 Quarterly

(see point 7. Water topping up interval)

### 3.5 Annually

In accordance with EN 1175-1 at least once per year, the insulation resistance of the truck and the battery must be checked by an electrical specialist. The tests on the insulation resistance of the battery must be conducted in accordance with EN 1987-1. The insulation resistance of the battery thus determined must not be below a value of 50 Ω per Volt of nominal voltage, in compliance with EN 62485-3. For batteries up to 20 V nominal voltage the minimum value is 1000 Ω. Proceed to the quarterly maintenance, including the measurement of electrolyte S.G. at the end of charge. For batteries equipped with optional electrolyte circulation system, the filter of the air pump has to be checked during the annual maintenance and eventually to be cleaned or replaced. Earlier replacement of the filter is necessary if for undefined reasons (no leaks in the air pipes) the defect signal of the electrolyte circulation system on the charger or on the battery (on DC air pump or remote signal) is illuminated. During the annual maintenance, check the correct operation of the air pump.

## 4. Care of the battery

The battery should always be kept clean and dry to prevent tracking currents. Cleaning must be done in accordance with the ZVEI code of practice "The Cleaning of Vehicle Traction Batteries".

Any liquid in the battery tray must be extracted and disposed of in the prescribed manner. Damage to the insulation of the tray should be repaired after cleaning, to ensure that the insulation value complies with EN 62485-3 and to prevent tray corrosion. If it is necessary to remove cells it is best to call in our service department for this. Never use (apply) mineral grease on the battery, the sealing material of the terminal is incompatible and it can be permanently damaged. If it's necessary, use (apply) the silicone grease with TPF6.

## 5. Storage

If batteries are taken out of service for a lengthy period they should be stored in the fully charged condition in a dry, frost-free room. To ensure the battery is always ready for use a choice of charging methods can be made:

1. a monthly equalising charge as in point 2.3, or
2. float charging at a charging voltage of 2.27 V x the number of cells.

The storage time should be taken into account when considering the life of the battery.

## 6. Malfunctions

If malfunctions are found on the battery or the charger, our service department should be called in without delay. The measurements taken in point 3.3 will facilitate fault finding and their elimination.

A service contract with us will make it easier to detect and correct faults in good time.

## 7. Water topping up interval

Water Less® variant			Water topping up intervals	
Battery	Charger	Charge factor	1 shift operation	3 shift operation
Water Less	50 Hz	1.20	20 cycles (4 weeks)	20 cycles (2 weeks)
Water Less	HF	1.10	40 cycles (8 weeks)	40 cycles (5 weeks)
Water Less Airmix	HF	1.07	65 cycles (13 weeks)	65 cycles (8 weeks)
Water Less 20	HF/50 Hz	1.04	100 cycles (20 weeks)	100 cycles (12 weeks)

## STANDARD AND OPTIONAL EQUIPMENT

	Water Less	Water Less 20
Aqualevel	+	■
Airmix	+	■
Wi-iQ®	+	■
Blinky	■	+ <sup>1)</sup>

■ Standard    + Option    ✕ not available

<sup>1)</sup> batteries with 2 and 3 positive plates are supplied with Blinky, not with Wi-iQ as standard

## Aqualevel - Water refilling system (optional accessory)

### 1. Application

The water refilling system is used to automatically maintain the nominal electrolyte levels.

The charging gasses escape through the vent on each cell.

**NO WATERING IN THE FIRST 10 CYCLES.**

### 2. Function

A valve and a float together control the topping up process and maintain the correct water level in each cell. The valve allows the flow of water into each cell and the float closes the valve when the correct water level has been reached.

For fault-free operation of the water refilling system, please note the instructions below:

#### 2.1 Manual or automatic connection

The battery should be topped up shortly before completion of a full charge, as at this point the battery has reached a defined operational state resulting in satisfactory electrolyte circulation. Filling takes place when the connector (7) from the tank is connected to the coupling (6) on the battery.

Manual or automatic coupling has to be done in the intervals according point 7. (see point 7.)

#### 2.2 Filling time

Filling time depends on the utilisation rate and the corresponding battery temperature. Generally speaking, the top up process takes a few minutes and can vary according to the battery range; after this, if manual filling is being used, the water supply to the battery should be turned off.

### 2.3 Working pressure

The water refilling system should be installed in such a way that a water pressure of 0.2 to 0.6 bar is obtained (with at least 2 m height difference between the upper edge of the battery and the lower edge of the tank). Any deviation from this means that the system will not function properly.

### 2.4 Purity

The topping up water must be purified. The water used to refill the batteries must have a conductance of not more than 30 µS/cm. The tank and pipes must be cleaned before operating the system.

### 2.5 Pipe system on the battery

The pipe system to the individual battery cells must follow the battery's electrical circuit. This reduces the risk of current leakage in the presence of electrolytic gas causing an explosion (EN 62485-3). A maximum of 18 cells may be connected in a series.

The system should not be modified in any way.

### 2.6 Working temperature

In winter, batteries fitted with Aqualevel should only be charged or refilled in a room temperature above 0 °C.

### 2.7 Flow control

A flow indicator built into the water supply pipe to the battery monitors the filling process. During filling the water flow causes the built-in disc in the flow indicator to turn. When all the plugs are closed the disc stops, indicating that the filling process is complete.

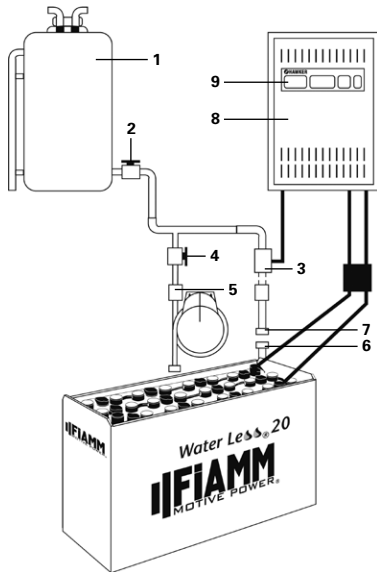

1. tank
2. outflow connector with ball valve
3. plug with magnetic valve
4. plug with ball valve
5. flow control
6. coupling
7. connector
8. battery charger
9. charger main switch

## Electrolyte circulation system (optional accessory)

### 1. Application

The electrolyte circulation system is based on the principle of pumping air into the individual battery cells. This system prevents electrolyte stratification and the battery charge is optimised. The electrolyte circulation is particularly beneficial for short charge times, boost or opportunity charging.

### 2. Function

The electrolyte circulation consists of a pipe system fitted in the cells. The Aeromatic diaphragm pump is fitted in the charger or separately mounted on the battery or vehicle. This diaphragm pump sends a low rate airflow into each cell which creates a circulating air stream inside the cell box. The air stream is continuous or pulsed depending on the battery voltage and pump type. The air supply is adjusted in accordance to the number of cells in the battery.

The pipe system to the individual battery cells must follow the existing electrical circuit. This reduces the risk of current leakage in the presence of electrolytic gas causing an explosion (EN 62485-3).

### 2.1 Use with separate pipe system

Air is supplied when the charger pipe system is connected to the battery pipe system (with blue ring).

### 2.2 Use with automatic connection of the pipe system

Connecting the charge plug with integrated air supply automatically supplies air to the battery.

### 2.3 Maintenance of air filter

Depending on the working conditions, the pump air filter should be changed at least once a year. In work areas with high levels of air-pollution, the filter should be checked and replaced more frequently.

### 2.4 Repair and maintenance

The system must be checked for leakage. The Fiamm Motive Power charger will display an error message to indicate leakage. Sometimes in the case of leakage the characteristic charging curve is switched over to the characteristic standard curve (without electrolyte circulation).

Faulty parts and faulty pipe sections must be replaced. Only Fiamm Motive Power original spare parts may be used, as these are designed for the pump air supply and will ensure correct functioning of the pump.

## Wi-iQ® (optional accessory)

Wi-iQ – the electronic device – will provide indications according to the table below.

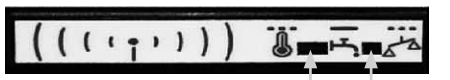
<p>Tricolour LED      Blue LED</p>
<b>Tricolour LED</b>
Green blinking = hardware OK Blue rapid blinking = wireless identification Red blinking = temperature warning > 55° C
<b>Blue LED</b>
Rapid blinking = wireless identification Slow blinking = voltage balance warning OFF - Flashing = electrolyte level is OK Light is constantly on = electrolyte level is low - please top up

The Wi-iQ is the electronic device that communicates wirelessly to download the battery key information for better diagnostics & service. The device is fitted to a main DC cable on the battery to monitor and record data of current, voltage, temperature and electrolyte level (via optional external sensor). The LEDs on the Wi-iQ provide real time status of battery's condition.

The information is transferred to the PC via USB by Wireless communication.

### 1. Operation

**The Wi-iQ is suitable for use on all battery technologies  
Voltage range is 12V – 120V.**

The device records global data during the life of the battery. It will store data for 2,555 cycles (complete history stored by PC). The data can be analysed by the PC software program: state of charge, temperature warnings and low electrolyte level warnings.

### 2. Clear visibility

Selecting the Exception & Detailed Reports will provide information on the condition of your battery and any actions that are necessary. Wi-iQ Report will quickly enable you to get a handle on your battery fleet charging & discharging characteristics. With information by battery family (truck type) you can see depth of discharge charts, cycles, charging and much more.

### 3. Very easy to use

Plug in USB modem to the PC, scan the Wi-iQ and up-load the data. Wi-iQ Report is a PC Software running on Windows 7, 8, XP or Vista. A USB wireless key is used for downloading Wi-iQ data in to a SQL database.

#### Back to the manufacturer!

Batteries with this sign must be recycled.  
Batteries which are not returned for the recycling process must be disposed of as hazardous waste!

**When using motive power batteries and chargers, the operator must comply with the current standards, laws, rules, and regulations in force in the country of use!**



**Pb**

