

## Hawker® Robust ATEX

*ATEX battery certified*  
*Ex I M2 eb I*

# Technical Manual Hawker® Robust ATEX

## CONTENTS

Introduction.....	2
Rating Data.....	2
Safety.....	3
Service.....	3
Handling.....	3
Commissioning and operation.....	3
Maintenance, repair.....	4
Every day.....	4
Weekly.....	4
Monthly.....	4
Annually.....	5
Three years maintenance.....	5
Discharge.....	5
Recharge.....	5
Specific Gravity.....	5
Temperature.....	5
Surrounding area conditions.....	5
Effect of explosive atmosphere on materials.....	5
Protection against other hazards.....	5
Hazards arising from different ignition sources.....	5
Withstanding attack by aggressive substances.....	5
Storage.....	6
Malfunctions .....	6
<b>Aquamatic water refilling system (optional accessory)</b>	
Application.....	6
Function.....	6
Manual or automatic connection.....	6
Filling time.....	6
Working pressure.....	6
Purity.....	6
Pipe system on the battery.....	6
Working temperature.....	6
Flow control.....	6
<b>Hawker® Electrolyte circulation system (optional accessory)</b>	
Application.....	6
Function.....	6
Maintenance of air filter.....	6
Repair and maintenance.....	7
Charging instructions.....	7
Normative references.....	7
Literature referring to the information.....	7

## INTRODUCTION

These batteries are intended for use in are with potentially risk atmosphere, classified Ex I M2 (based on EU Directive 94/9/EC). Battery is used as a source of energy for mining machines like locomotives for staff or material transport.

Design of those batteries is based on norms EN 60079-0:2009, EN 60079-7:2007 and EN 60079-31:2008, other relevant norms and standards and is based on EU Directive 94/9/EC as well.

### EC Type Certification: BVS 13 ATEX E 092

Batteries should be in perfect condition and free from any damage. If any damage is identified or any accessories are missing, please contact your supplier within the first 24 hours of receiving this product.

Battery tray must comply IP 23 – cable exit of battery must be covered and sealed by appropriate connector-box (approved for the same range of use) or with plate adapter for cable glands installation (Part number: 480-0899-900-PL1). Connector-box or adapter should be sealed by Loctite 5368.

#### Marking:

This operational manual is valid for EX-batteries with cell types PzB, PzS, PzM based on norm EN 60254-2.

Batteries are allowed to be operated in area described below:



CE marking is based on conformity with EU Directive 94/9/EC



#### Quality Assurance Notification:

SIRA 01 ATEX M103 dated 02.08.2013

#### Battery manufacturer:

EnerSys s.r.o., Nádražní 555, 267 24 Hostomice pod Brdy, Czech republic

#### Battery brand: Hawker® Robust

#### Special conditions for safe use:

Battery tray must comply IP 23 – cable exit of battery must be covered and sealed by appropriate connector-box or with plate adapter for cable glands installation (part No.: 480-0899-900-PL1). Connector-box or adapter should be sealed by Loctite 5368.









#### Delivered battery:

**Battery .....V ..... Ah Hawker® Robust**

## RATING DATA

1. Nominal capacity C5	: see type plate
2. Nominal Voltage	: 2.0 V x No of cells
3. Nominal discharge current	: C <sub>5</sub> / 5 h
4. Nominal S.G. of electrolyte*	: 1.29 kg/l
5. Rated temperature	: -20°C up to 40°C
6. Nominal electrolyt level	: up to electrolyte level mark „ max.“

\*Will be reached within the first 10 cycles

	<ul style="list-style-type: none"> <li>• Pay attention to the operation instruction and fix them close to the battery.</li> <li>• Work on batteries to be carried out by skilled personnel only!</li> </ul>		<ul style="list-style-type: none"> <li>• Electrolyte is highly corrosive.</li> </ul>
	<ul style="list-style-type: none"> <li>• Use protective glasses and clothes when working on batteries. Pay attention to the accident prevention rules as well as EN 50272-3 and EN 50110-1.</li> </ul>		<ul style="list-style-type: none"> <li>• Batteries and cells are heavy. Ensure secure installation!</li> <li>• Use only suitable handling equipment e.g. lifting gear in accordance with VDI 3616.</li> </ul>
	<ul style="list-style-type: none"> <li>• No smoking!</li> <li>• Do not expose batteries to naked flames, glowing embers or sparks, as it may cause the battery to explode.</li> </ul>		<ul style="list-style-type: none"> <li>• Dangerous electrical voltage!</li> </ul>
	<ul style="list-style-type: none"> <li>• Acid splashes in the eyes or on the skin must be washed with water. In case of accident consult a doctor immediately!</li> <li>• Clothing contaminated by acid should be washed in water.</li> </ul>		<ul style="list-style-type: none"> <li>• Pay attention to the hazards that can be caused by batteries.</li> </ul>
	<ul style="list-style-type: none"> <li>• Risk of explosion and fire, avoid short circuits!</li> <li>• Caution: Metal parts of the battery are always live. Do not place tools or other metal objects on the battery!</li> </ul>		

Ignoring the operation instructions, repair with non-original parts or using additives for the electrolyte will render the warranty void.

## SAFETY

- **ATTENTION!** Batteries above 60V mean dangerous voltage for human body!
- Always remember that the battery is a source of power, even when fully discharged sufficient energy remains in the battery to cause serious damage.
- ATEX batteries are not allowed to be connected or disconnected under the load in risk atmosphere.
- Transport of ATEX battery through area with explosion atmosphere is allowed only with connected plugs or protected / closed sockets by covers.
- ATEX batteries are not allowed to be connected or disconnected under the load even outside explosion atmosphere.
- Never open the battery cover in a hazardous area.
- Only approved (for appropriate range of use in sense of 94/9/EC) sockets / plugs are allowed to be used for battery connection to the device.
- Damaged ATEX batteries are prohibited to be operated. This applies for battery cables and sockets/plugs as well.
- Smoking, open fire or sparks are in surrounding of ATEX battery prohibited. It could represent risk of explosion!!
- Do not place any objects in ATEX battery – risk of short-cut!
- After maintenance filling plugs of cells must be always closed. Usage of battery with opened filling cell plugs in risk atmosphere is prohibited.
- Ventilation openings should be checked for damage. Spacing of ventilation slots may not be greater than 12 mm. If any damage of ventilation openings is identified the battery is no more allowed to be operated in risk explosion atmosphere.
- Locking of battery covers must work properly and smoothly. Covers can be opened only by usage of special tool (hexagonal key).
- Isolation resistance of battery is to be measured annually (at least) – see EN 50272-3!
- ATEX batteries must be kept in dry (surface) and clean stage. Remaining liquid in battery tray should be exhausted by provided tubes. Coal dust must be removed.
- All repairs or work on ATEX battery must respect safety instructions stated in this operational manual!

## SERVICE

Your local authorized service engineer provides local help and support. This handbook gives guidelines of a general nature; our engineer will help you to interpret your needs in relationship to your particular requirements. Your authorized engineer can answer the questions that are beyond the scope of this manual and can obtain specialist help if required. Your battery is an expensive investment and designed for use in a hazardous area, it is our aim to help you to obtain the best possible efforts of it. Please do not hesitate to call your local service center if you have any questions relating to the battery.

## HANDLING

Lead acid batteries are very heavy. Always use approved moving equipment when attempting to change batteries. When lifting and handling the Ex batteries use the correct approved lifting equipment and keep the battery in an upright position. Due to the wide variation in types of electric vehicles, designs of battery containers, equipment used and methods of battery changing, it is not possible to give detailed instructions to be followed when changing the batteries on an electrical vehicle. The manufacturer of the vehicle or

the battery changing equipment must supply the correct method and procedure.

Damaged lifting equipment on the battery represents safety risk. Damaged parts must be repaired or replaced. Never lift battery when covers are opened. Prior lifting of battery plugs and earthing cable needs to be disconnected.

Battery unpacking is in explosion atmosphere not allowed. Carefully remove the packing materials and check exactly battery tray (enclosure) for damages. Battery end-cables are clearly marked by colour – red = positive, blue = negative. Make sure that the batteries are always kept in an upright position to prevent spillage of the electrolyte. If the battery is not operated immediately after delivery, refer and follow clause „Storage“ of this manual.

## COMMISSIONING AND OPERATION

Installation and commissioning of ATEX battery is not allowed to be done in explosive atmosphere. Delivered battery should be inspected for any damage and whether it is in a perfect condition. If any damage realised or missing accessories, please contact battery supplier within 24 hours. Make sure that space for the battery installation in the vehicle is dry and the ventilation in perfect condition.

Battery should seat in vehicle firmly. Follow instruction of vehicle how to lock battery in its position (rollover risk). Use suitable fastening equipment to prevent battery movement when driving the vehicle.

Dry charged ex-traction batteries are to be filled according to the additional, separate commissioning and operational instruction.

### ATEX batteries connection with device

The electrical connection between ex-vehicle and ex battery or charger may be performed only by supplied or specified battery connectors. The components must be plug-compatible and must have type-examination certificate (within an appropriate range). Operational manual of sockets / plugs needs to be followed.

### ATEX batteries with hard connection to device

#### ATTENTION:

Non-insulated cable-ends remain live. To prevent short-cut positive cable needs to be connected first. This work must be carried out by a qualified electrician. The cables must be flexible and long enough to prevent excessive stress.

#### Valid installation regulations must be observed / followed.

Ex batteries are fitted with a connection for equipotential bonding. This potential equalization is marked with a grounding sticker.

#### ATTENTION:

The Ex battery may be operated in hazardous areas only if a potential equalization is connected!

If there is more than 8 weeks between battery delivery and commissioning electrolyte level is to be checked. When the level of electrolyte is below deflector or upper edge of separators demineralised water (EN 43530, clause 4) needs to be refilled. Then the battery should be recharged (according to clause 7 of this manual) and electrolyte level adjusted (refilled) by demineralised water up to indicated level.

Safety of ex devices with concept of protection “e” is setting up conditions of use. That is why ex battery must be in perfect technical condition. Maintenance should be carried out regularly - refer and follow clause „Maintenance, repair“ of this manual.

The current load of ex battery and socket / plug must not exceed the information provided in type examination certificates. Nominal current of battery is 5-hours current. Battery deep discharge should be avoided.

Battery covers must be opened within charging. Cover should stay opened after charging as well to let the raising gas escape and to reduce risk of explosive concentration existence.

ATEX batteries can be charged in explosive atmosphere but **under special conditions prescribed by producer of the battery only.**

Battery user has to carry out an evaluation / assessment and eventually take additionally measures, e.g. forced ventilation.

See also EN 60079-7:2007 clause 5.7.3 to 5.7.7.

#### ATTENTION:

Cells temperature may not exceed 55°C within battery operation. Surface temperature can, in explosive atmosphere, be max. 85°C.

Electrolyte temperature should be checked by the end of charging. This can be done with a conventional glass thermometer. The battery temperature before the start of the load must not exceed 43°C.

In case that temperature is >55°C during charging or by the end of charging, the battery must be cooled down.

#### Special features for use in explosive dust atmospheres

Battery end user must check whether dust occurring in his areas is reactive with sulphuric acid. In case of any doubts, contact battery manufacturer. The battery must be cleaned regularly. Coal dust must not cumulate in or on the battery up to dangerous layer thickness.

### MAINTENANCE, REPAIR

Maintenance and repair work on ex batteries must be carried out only by appropriately qualified personnel. We recommend using the service organization of the battery manufacturer.

If any defects or errors occur on the ex-battery or sockets/plugs, defective device must be brought outside the hazardous area immediately. Do not attempt to disassemble the battery or ex-components.

Ex-protection-relevant components such as plugs, locks, cable ducting, ventilation openings shall be subjected to a visual inspection prior to use. Operation in potentially explosive atmospheres is not permitted, if damage is visible.

The ventilation slots comply with one hand touch protection according to IP 23, on the other hand they provide adequate ventilation, ie they must have 12 mm column (eg deviations closer column, possible manufacturer specification!). Mechanical damage to the covers, for example by stones, must be corrected immediately. Either by „straightening“ of the column cover and or replacing the defective lid.

The lid lock must be checked for proper function. Batteries without secured lid must not be used in hazardous areas. Damaged locks must be replaced with original parts.

Batteries must always be kept in a clean and dry condition in order to avoid the occurrence of creepage current. Liquid in the battery container is to be exhausted and disposed properly.

Damaged insulation of battery tray needs to be repaired immediately to prevent further corrosion and then insulation resistance acc. EN 50272-3 is to be checked. If the cells need to be removed because of insulation reparation, please contact service organization of battery producer immediately.

Battery cells are components that have a significant influence on the type of protection. The replacement must be performed by qualified personnel only! The screws for cell connectors and end fittings must not be used more than once, they must be replaced with new screws (tightening torque 25 + 2 Nm)!

Only approved original spare parts from the manufacturer may be used for the repair. Cells with components certificate (SIRA 01 ATEX 3016 U or SIRA 01 ATEX 3019 U), which must be in the same range of use!

Maintenance and repair work must be documented with the operator. Any maintenance or repair must follow EN 60079-19.

### EVERY DAY:

Recharge the battery after discharge.

- **Remember** never charge an Ex battery in a hazardous area even if approved charging equipment is available. Always check that the charger is operating correctly.
- Check the electrolyte levels at the end of charging process and top up the battery if necessary (respect max level). The correct level is to the top of the level indicator.
- For automatic topping system refer to section part “Aquamatic”.

If too much water is added, the expansion during recharge will cause the electrolyte overflow, therefore weakening the strength of the electrolyte. If insufficient water is added the top of the cell plates will become exposed, reducing the performance and working life of the battery.

Use approved demineralised (distilled) water only. The ‘standard’ of purity of water required for topping up is given in DIN 43530-4.

Devices for topping up water production, topping up devices or automatic water filling systems can be obtained from your local supplier or service dept. Note that topping up water must only be held in and dispensed from non-metallic containers.

**Never top up with acid.** It may occur that an acid adjustment is required, in that case, please consult your local service dept.

### WEEKLY:

- Please note down any cell which is consuming too much or too less water. If this occurs please contact your local service dept.
- Check all connections and take off leads for any frayed or worn insulation. If frayed wires or worn insulation is noted, get the battery **out of service immediately** and place it in a safe area that is outside the hazardous area. **Do not attempt to repair an Ex battery.** Call your local service dept.
- Check that all insulators and vent plugs are in place and that the battery plugs are of sound condition.

Ensure that the top of the battery is clean and dry. Dirt and moisture can provide tracking paths for the electricity and potentially cause a spark in a hazardous area.

### MONTHLY:

At the end of the charge the voltage of each cell should be measured with the charger switched on, and recorded. After charging has been completed, the electrolyte density, electrolyte temperature, and the electrolyte level of each cell are to be measured and recorded. If significant changes from earlier measurements or differences between the cells are obtained, further testing and maintenance by the service department should be requested. This should be done following a complete charge and minimum of 2 hours rest time.

Battery covers should work smoothly. There are lubrication points in area of battery cover bearings. Bearing need to be lubricated monthly by acid-free grease.

The lifting elements of the battery should be checked. When the lifting hole shows strong deformation (press out) it is necessary to verify remaining load capacity (consultation with battery manufacturer is required).

#### Measure and record:

- total voltage
- voltage per cell
- if the voltage reading are irregular, also check the S.G. of each cell.

(See Water topping interval).

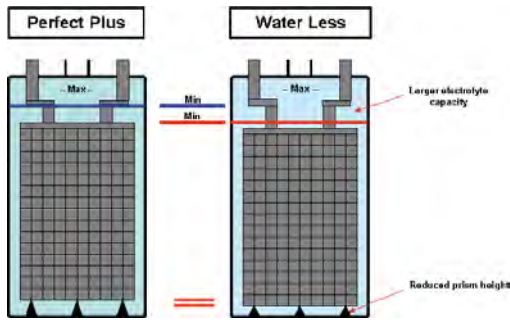

#### Water Less topping up intervals

PzM Variant	Water topping up intervals	
	1 shift operation*	3 shift operation**
PzM - 4 W (PzM + 50 Hz Cf = 1.2)	20 Cycles (4 weeks)	20 Cycles (2 weeks)
PzM - 8 W (PzM + Hf Cf = 1.10)	40 Cycles (8 weeks)	40 Cycles (5 weeks)
PzM - 13 W (PzM EC*** + Hf Cf = 1.07)	65 Cycles (13 weeks)	65 Cycles (8 weeks)

#### Remark

\* 80% DOD, 5 operating days per week, and average battery temperatures of 30°C

\*\* this number of cycles can be reduced if operating 3 shift and with high battery temperatures!

\*\*\* Electrolyte Circulation

### ANNUALLY

As needed, but at least once a year, the insulation resistance according to EN 1175-1 of the vehicle and the battery (if incl. plug device) must be checked by a competent person.

The tests on the insulation resistance of the battery must be conducted in accordance with EN 1987 part 1. The insulation resistance of the battery must not be below a value of 50 Ω per Volt (nominal voltage), in compliance with EN 50272-3. For batteries up to 20 V nominal voltage the minimum value is 1000 Ω.

Proceed to the maintenance, including the measurement of electrolyte S.G. at the end of charge. The filter of the air pump (if air mixing is provided) has to be checked during the annual maintenance and eventually to be cleaned or replaced. Earlier replacement of the filter is necessary when, for undefined reasons (no leaks in the air pipes) the defect signal of the air mixing system on the charger or on the battery (on DC air pump or remote signal) is illuminated. During the annual maintenance, check the correct operation of the air pump (if provided).

### THREE YEARS MAINTENANCE

**Batteries, which are operated as a suspended batteries have higher continuous load of the lifting elements. Depending on the conditions these lifting elements must be checked including the welds at least every three years for hairline cracks and continuous load damage, e.g. with the magnetic particle crack detection (please contact the battery manufacturer)!**

### DISCHARGE

Be sure that all ventilation openings are not sealed or covered. Electrical connections (e.g. plugs) can be affected only in the open circuit condition. To achieve the optimum life of the battery, operating discharges of more than 80% of the rated capacity should be avoided (deep discharge). This corresponds to an electrolyte specific gravity of 1.14 kg/l at 30°C at the end of the discharge.

Discharged batteries must be recharged immediately and must not be left discharged. This also applies to partially discharged batteries.

It is recommended that the battery is discharged evenly. Usage of voltage taps across a part of the battery is discouraged. To overcome this problem a D.C.-D.C. converter must be used, which allows auxiliary loads to be supplied from the whole battery.

#### NOTE:

**The D.C.-D.C. converter must be certified for use in a hazardous area as well as the auxiliary equipment.**

Battery performance is directly related to temperature. Batteries are rated at 30°C. Where the battery temperature is lower, the available performance is reduced.

Additional capacity is therefore required when the batteries are to be used in areas of low ambient temperatures (e.g. cold stores).

### RECHARGE

#### NOTE:

**Ex battery should not be charged in hazardous areas. Cover of battery should remain opened during charge and 30 minutes after its end. For different rules should be required to contact the battery manufacturer or your service partner.**

Only direct current (DC) must be used for charging. Only charging procedures in accordance with DIN 41773-1 and DIN 41774 are permitted. For charging use only assigned charger, suitable for the size of the battery, in order to avoid overloading of the electric cables and contacts, unacceptable gassing and escape of electrolyte from the cells. In the gassing stage the current limits given in EN 50272-3 must not be exceeded. If the charger was not purchased together with the battery, it is the best to ask for charger suitability evaluation by the manufacturer's service department. When charging, proper provision must be made for venting of the charging gases. Doors, battery container lids and the covers of battery compartments must be opened or removed. During the charge the battery must be removed from the closed battery compartment on the truck. The ventilation must comply to EN 50272-3 standard. The vent plugs should stay on the cells and remain closed. With the charger switched off connect up the battery, ensuring that the polarity is correct (positive to positive, negative to negative). Now switch on the charger. Temperature of the electrolyte rises by about 10°C when charging, so charging should only begin if the electrolyte temperature is below 43°C. The electrolyte temperature of batteries should be at least +10°C before charging otherwise a full charge will not be achieved. The charge is considered as finished when the specific gravity of the electrolyte and the battery voltage has remained constant for two hours.

#### Equalizing charging

**Equalizing charges are used to safeguard the life of the battery and to maintain its capacity. This charging must be applied after deep discharges, repeated incomplete recharges or charges according IU characteristic curve. Equalizing charges are carried out after normal charging. The charging current must not exceed 5 A/100 Ah of rated capacity (end of charge). Watch the temperature!**

### SPECIFIC GRAVITY

The rated specific gravity (S.G.) of the electrolyte is related to a temperature of 30°C and the nominal electrolyte level in the cell in fully charged condition. Higher temperatures reduce the specified gravity of the electrolyte, lower temperatures increase it. The temperature correction factor is -0.0007 kg/l per °C, e.g. an electrolyte specific gravity of 1.28 kg/l at 45°C corresponds to an S.G. of 1.29 kg/l at 30°C.

The electrolyte must conform to the purity regulations in DIN 43530 Part 2.

### TEMPERATURE

An electrolyte temperature of 30°C is specified as the rated temperature. Higher temperatures shorten the life of the battery; lower temperatures reduce the capacity available. 55°C is the upper temperature limit and is not acceptable as an operating temperature.

The temperature on the surface must never exceed 85°C in hazardous area. Charging should only begin if the electrolyte temperature is below 43°C. If electrolyte temperature reaches 55°C during the charge, wait for the cooling before to use the battery in the hazardous area. If a hot battery is detected it should be taken out of the controlled zoned area and remained to cool to ambient temperature.

An investigation should be carried out, why the battery is getting hot before it is returned back into service. Possible reasons, why the battery might be getting hot is that there could be a fault in the equipment which is powered by battery or some of cells of battery may be defective. In the case of a suspected battery problem contact your local service centre.

### SURROUNDING AREA CONDITIONS

The apparatus is designed to cope with the intended surrounding area conditions.

### EFFECT OF EXPLOSIVE ATMOSPHERE ON MATERIALS

The materials selected are not known to react with any explosive atmospheres to which the apparatus may be subjected.

### PROTECTION AGAINST OTHER HAZARDS

The apparatus does not cause injury or harm when used as specified in the installation and operation manual.

### HAZARDS ARISING FROM DIFFERENT IGNITION SOURCES

The apparatus does not produce ignition capable electrical sparks or arcs. The apparatus has also been designed not to produce potential ignition sources from electromagnetic, acoustic, optical or other such external energy sources.

## WITHSTANDING ATTACK BY AGGRESSIVE SUBSTANCES

The individual cell contains sulphuric acid: These cells and enclosure which make up the apparatus are constructed from materials that are resistant to acid attack see manufacturer's data sheet.

## STORAGE

If batteries are taken out of service for a longer period they should be stored in the fully charged condition, in a dry, frost-free room. To ensure the battery is always ready for use one of following points should be followed:

- monthly equalizing charge as in point 'MONTHLY'
- float charging at a charging voltage of 2.27 V x the number of cells.

The storage time should be taken into account when considering the life of the battery.

## MALFUNCTIONS

If any malfunctions are found out on the battery or the charger, our service department should be called in without any delay. The measurements (steps) applied acc. point 'HANDLING' will facilitate fault finding and its elimination. A service contract battery producer will simplify detection and correction of faults in short time.

To avoid any damage following points should be observed:

- If batteries are filled with water at the wrong time, it can come to an overflow of cells (corrosion, insulation fault)
- Use a suspension for the charger cables to avoid damage of connectors installed on their ends.
- Close battery covers only when hinged eyes (if available on the battery) are folded out.
- Checked opened covers whether there is no any influence of lateral forces – risk of buckling.

Ask battery manufacturer for suitable and allowed charging methods.

## AQUAMATIC WATER REFILLING SYSTEM (OPTIONAL ACCESSORY)

### APPLICATION

The water refilling system is used to automatically maintain the nominal electrolyte levels. The charging gasses escape through the vent on each cell.

### FUNCTION

A valve and a float together control the topping up process and maintain the correct water level in each cell. The valve allows the flow of water into each cell and the float closes the valve when the correct water level has been reached.

For fault-free operation of the water refilling system, please note the instructions below:

### MANUAL OR AUTOMATIC CONNECTION

The battery should be topped up shortly before completion of a full charge, as at this point the battery has reached a defined operational state resulting in satisfactory electrolyte circulation. Filling takes place when the connector (7) from the tank is connected to the coupling (6) on the battery.

- If manual connection is used the battery should only be connected to the filling system once a week.
- If automatic coupling is used (with a magnetic valve controlled by the charging apparatus) the charger main switch selects the correct moment for filling.

**NOTE:** In this case we recommend a water refilling at least once a week to ensure the right level of the electrolyte.

- In multiple shift and warm ambient temperature operations, it may be necessary to have shorter topping up intervals.

### FILLING TIME

Filling time depends on the utilisation rate and the corresponding battery temperature. Generally speaking, the top up process takes a few minutes and can vary according to the battery range; after this, if manual filling is being used, the water supply to the battery should be turned off.

## WORKING PRESSURE

The water refilling system should be installed in such a way that a water pressure of 0.2 to 0.6 bar is obtained (with at least 2 m height difference between the upper edge of the battery and the lower edge of the tank). Any deviation from this means that the system will not function properly.

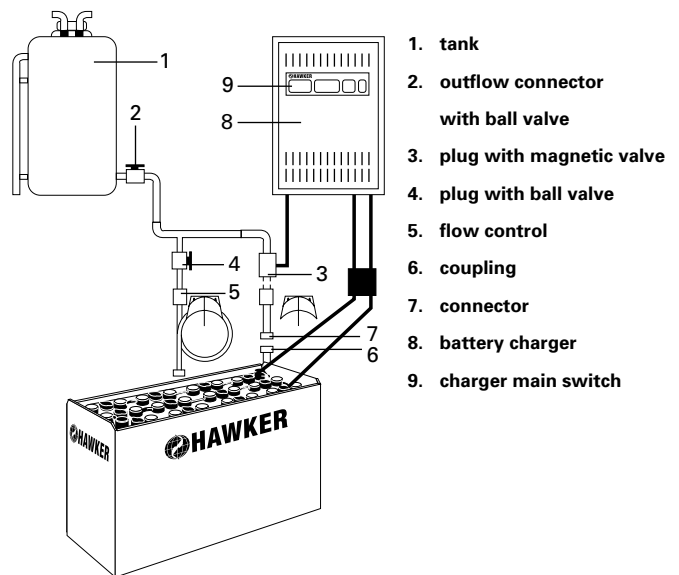

## PURITY

The topping up water must be purified. The water used to refill the batteries must have a conductance of not more than 30 µS/ cm. The tank and pipes must be cleaned before operating the system.

## PIPE SYSTEM ON THE BATTERY

The pipe system to the individual battery cells must follow the battery's electrical circuit. This reduces the risk of current leakage in the presence of electrolytic gas causing an explosion (EN 50272-3). A maximum of 18 cells may be connected in a series. The system should not be modified in any way.

## WORKING TEMPERATURE

In winter, batteries fitted with Aquamatic should only be charged or refilled in a room temperature above 0°C.

## FLOW CONTROL

A flow indicator built into the water supply pipe to the battery monitors the filling process. During filling the water flow causes the built-in disc in the flow indicator to turn. When all the plugs are closed the disc stops, indicating that the filling process is complete.

## HAWKER® ELECTROLYTE CIRCULATION SYSTEM (OPTIONAL ACCESSORY)

### APPLICATION

The electrolyte circulation system is based on the principle of pumping air into the individual battery cells. This system prevents electrolyte stratification and the battery charge is optimised using a charge factor of 1.07. The electrolyte circulation is particularly beneficial for heavy duty use, short charge times, boost or opportunity charging and in high ambient temperatures.

### FUNCTION

The Hawker® electrolyte circulation consists of a pipe system fitted in the cells. A Hawker Aeromatic diaphragm pump is fitted in the charger or separately mounted on the battery or vehicle. This diaphragm pump sends a low rate airflow into each cell which creates a circulating air stream inside the cell box. The air stream is continuous or pulsed depending on the battery voltage and pump type. The air supply is adjusted in accordance to the number of cells in the battery. The pipe system to the individual battery cells must follow the existing electrical circuit. This reduces the risk of current leakage in the presence of electrolytic gas causing an explosion (EN 50272-3).

## MAINTENANCE OF AIR FILTER

Depending on the working conditions, the pump air filter should be changed at least once a year. In work areas with high levels of air-pollution, the filter should be checked and replaced more frequently.

## REPAIR AND MAINTENANCE

The system must be checked for leakage. The Hawker charger will display an error message to indicate leakage. Sometimes in the case of leakage the characteristic charging curve is switched over to the characteristic standard curve (without electrolyte circulation).

In case of faulty parts, contact Hawker service. Only Hawker original spare parts may be used, as these are designed for the pump air supply and will ensure correct functioning of the pump.

## CHARGING INSTRUCTIONS

- Only direct current must be used for charging.
- Only connect the battery assigned to a charger, suitable for the size of battery (see type label of the battery), in order to avoid overloading of the electric cables and contacts, unacceptable gassing and the escape of electrolyte from the cells.
- In the gassing stage the current limits given in EN 50272-3 must not be exceeded.
- If the charger was not purchased together with the battery it is best to have its suitability checked by the manufacturer's service department.
- "Iula" characteristics should be used for charging with following parameters:\*

$$I1 = C_5 / 20 \text{ (A)}$$

$$I2 = I_1 / 2 \text{ (A)}$$

$$\text{Number of cells} = \text{battery voltage} / 2$$

*\*) all information for calculation of above mentioned values are mentioned on battery label*

- Doors, battery container lids and covers of battery compartments must be opened or removed. During the charge the battery must be removed from the closed battery compartment on the truck.
- The ventilation of charging area must comply to EN 50272-3 standard.
- With the charger switched off connect up the battery, ensuring that the polarity is correct. (positive to positive, negative to negative).
- Now switch on the charger. When charging the temperature of the electrolyte rises by about 10°C, so charging should only begin if the electrolyte temperature is below 43°C.
- The electrolyte temperature of batteries should be at least +10°C before charging otherwise a full charge will not be achieved.
- A charge is finished when the specific gravity of the electrolyte and the battery voltage have remained constant for two hours.

Above mentioned instruction should be place in charging place to be visible for battery operators.

For proper charger setting contact battery producer or producer of charger, if not supplied with battery.

## NORMATIVE REFERENCES

Directive	94/9/EC
EN 1987-1:1997	Electrically propelled road vehicles - Specific requirements for safety - Part 1: On board energy
EN 50110-1:2004	Operation of electrical installations
EN 50272-3:2002	Safety requirements for secondary batteries and battery installations - Part 3: Traction
EN 60079-0:2009	Explosive atmospheres - Part 0: Equipment - General requirements
EN 60079-7:2007	Explosive atmospheres - Part 7: Equipment protection by increased safety „e“
EN 60079-31:2009	Explosive atmospheres - Part 31: Equipment dust ignition protection by enclosure „t“
IEC 60254-2:2008	Lead-acid traction batteries - Part 2: Dimensions of cells and terminals and marking of polarity on cells
VDI 3616	Lifting device for traction batteries of industrial trucks

DIN 41773-1	Static power convertors; semiconductor rectifier equipment with IU-characteristics for charging of lead-acid batteries, guidelines
DIN 41774	Static power convertors; semiconductor rectifier equipment with W-characteristic for charging of lead-acid batteries; requirements
DIN 43530-2	Accumulators; electrolyte and refilling water; electrolyte for lead acid batteries
DIN 43530-4	Accumulators; electrolyte and refilling water; water and refilling water lead acid batteries and alkaline batteries

## LITERATURE REFERRING TO THE INFORMATION

Directive	1999/92/EC
EN 1127-1	Explosive atmospheres - Explosion prevention and protection - Part 1: Basic concepts and methodology
EN 1127-2	Explosive atmospheres - Explosion prevention and protection - Part 2: Basic concepts and methodology for mining
EN 1175-1	Safety of industrial trucks - Electrical requirements - Part 1: General requirements for battery powered trucks
EN 1889-2:2003+A1:2009	Machines for underground mines - Mobile machines working underground - Safety - Part 2: Rail locomotives
EN 60079-1	Explosive atmospheres - Part 1: Equipment protection by flameproof enclosures „d“
EN 60079-19	Explosive atmospheres - Part 19: Equipment repair, overhaul and reclamation
EN 60204-1:2006+A1:2009	Safety of machinery - Electrical equipment of machines - Part 1: General requirements
EN 60529:1991+A1:2000	Degrees of protection provided by enclosures (IP code)

### Disposal and back to the manufacturer!

Always dispose of the battery container and cells through your local service depot. Do not attempt to dismantle the battery or the cells in any way. Once the product has failed and is no longer repairable store outside the Zoned area until removed for reclaim.

Batteries with this sign must be recycled. Batteries which are not returned for the recycling process must be disposed of as hazardous waste!

**When using motive power batteries and chargers, the operator must comply with the current standards, laws, rules, and regulations in force in the country of use!**





Wherever you do business, EnerSys® can support you with motive power energy. The Hawker® branded battery range, matched chargers and systems provide trouble free performance under the most demanding service conditions. Our strategically located manufacturing plants are efficient and responsive with a culture of continuous improvement and added value for our business partners.

EnerSys has an enviable position in technology leadership and with significant investment in research and development we intend to stay at the leading edge in product innovation. The recently developed energy solutions: Hawker XFC™ batteries and modular HF chargers: Lifetech®, Life IQ™ and LifeSpeed IQ™, have defined new benefits for our customers: faster recharge, more machine availability, lower operating and investment costs, reduced carbon footprint. Our team of development engineers is driven by the desire to build the best energy solutions and works closely with our customers and suppliers to identify development opportunities. Our bias for rapid innovation means we get new products to market fast.

EnerSys's integrated sales and service network is dedicated to providing our customers with the best solutions and after-sales support for their business. Whether you require 1 battery or a complete fleet of batteries, chargers, a battery handling system and a state of the art fleet management system, you can count on us. EnerSys is the world's largest industrial battery manufacturer and we are dedicated to being the best.



**European Headquarters:**

**EnerSys EMEA**  
EH Europe GmbH  
Löwenstrasse 32  
8001 Zürich  
Switzerland  
Phone: +41 44 215 74 10  
Fax: +41 44 215 74 11

**Local contact:**

**Energys Ltd**  
Oak Court  
Clifton Business Park  
Wynne Avenue  
Swinton  
Manchester M27 8FF  
Phone: 0161 794 4611  
Fax: 0161 727 3809

Please refer to the website address for details of your nearest EnerSys office: [www.energys-emea.com](http://www.energys-emea.com)

© 2014 EnerSys. All rights reserved. All trademarks and logos are the property of or licensed to EnerSys and its affiliates unless otherwise noted.