

## Alpha Technologies' Method of Procedure:

### Field Retrofit kit to replace CXCM4 (in Vista I & II) with CXC-HP PN: 0380514-001 / 0380514-002/ 0380514-003

#### I) Summary

The purpose of this MOP is to detail how to replace a Cordex CXCM4 controller with CXC-HP controller in an existing Vista II power system having 1, 2 or 4 Tiers of distribution. This MOP will cover the generic requirements for mounting and system wiring.

- Section 1; Replace CXCM4 with kit 0380514-001 (1 Tier) and 0380514-002 (2 Tier)
- Section 2; Replace CXCM4 with a rectifier on Vista I (1 Tier) or II (2 Tier)
- Section 3; Replace CXCM4 with kit 0380514-003 (4 Tier)
- Section 4; Replace CXCM4 with a rectifier on Vista II (4 Tier)

#### II) Safety Precautions

Review the safety instructions in the power system manual, and the battery manufacturer's safety recommendations.

**Note: If power system is equipped with an LVD Inhibit switch, turn switch to the Override In, Manual or Inhibit position to prevent interruption of power to the loads.**

#### III) Tools and hardware required

- Flat head screwdriver [Blade width 3/32 in (2.4 mm)]
- #2 Stubby Philips screwdriver
- Side Cutter
- 3/8" Nut driver for distribution door and ground strap removal
- DVM
- Laptop with browser (IE, Fire Fox or Chrome)
- Ethernet cable

#### IV) Preparation

Review the system schematics for the power system. Login to the CXCM4 controller and note the following settings and any other special settings.

- Voltage settings
- Battery settings
- Current settings
- Custom settings

1) **CXCM4 Controller replacement steps for kit 0380514-001 (1 Tier) and 0380514-002 (2 Tier)**

1.1 Remove the existing distribution door by removing the 4x hinge nuts and ground strap nut.

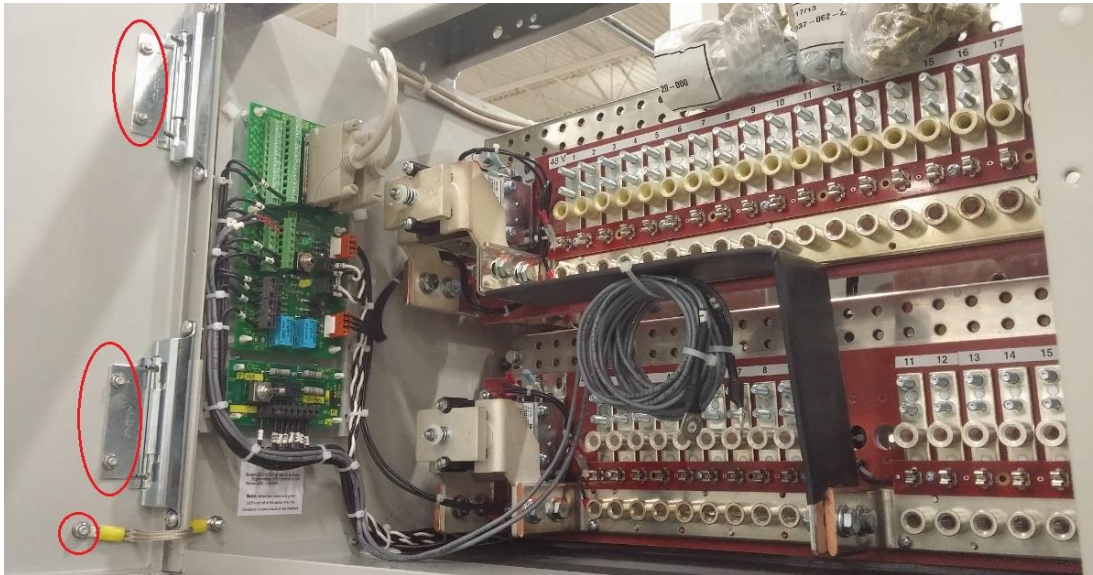

1.2 Remove the lock from the existing door and install in new door.



- 1.3 Install the new door and reattach the grounding strap using the same hardware removed in Step 1.1.

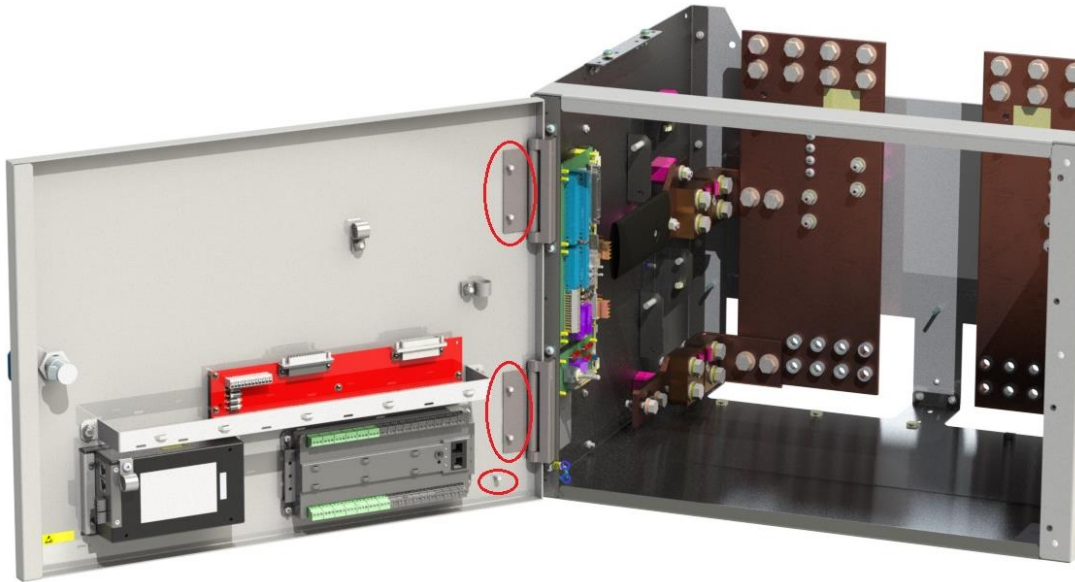

- 1.4 Remove CXCM4 controller module and install rectifier blank cover provided with the kit.



- 1.5 Disconnect 2x DB-25 cables from CXCM4 interface adapter.

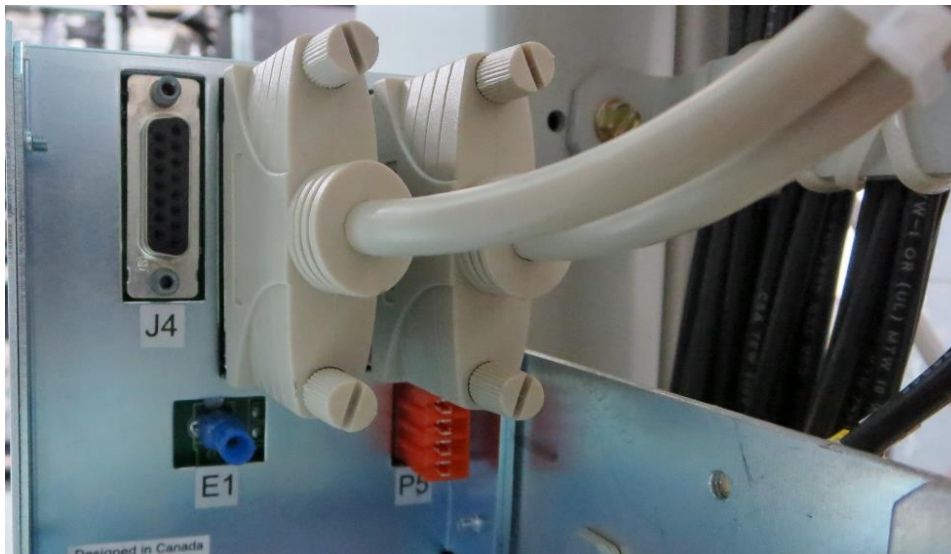

- 1.6 Route the 2x DB-25 cables in to the distribution.



1.7. Connect provided CAN cable and route to inside the distribution.

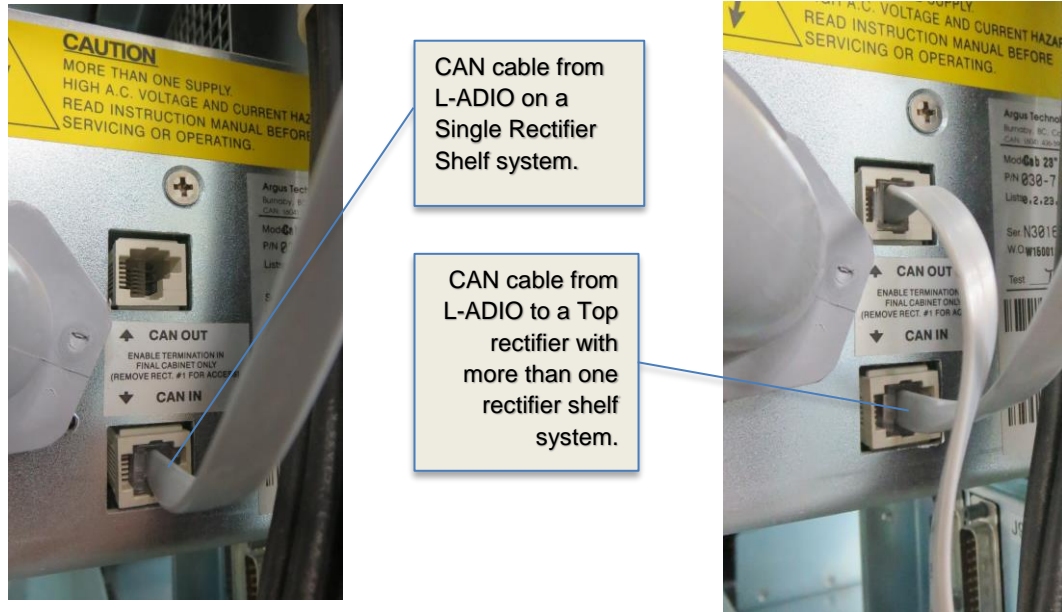

1.8. Route the 2x DB-25 cables and the CAN cable in to distribution. Do not remove any cables or wires from the CXCM4 interface PCB.

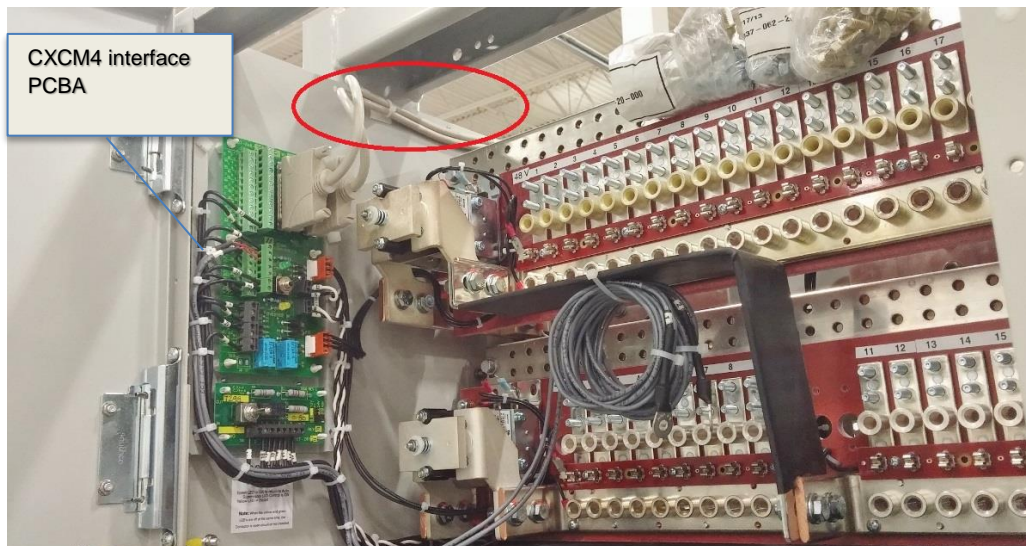

- 1.9. Route and connect the 2x DB-25 cables to the interface PCB and CAN cable to the CAN OUT port of the L-ADIO module. Connect the supplied power cable to the interface PCB terminal block.

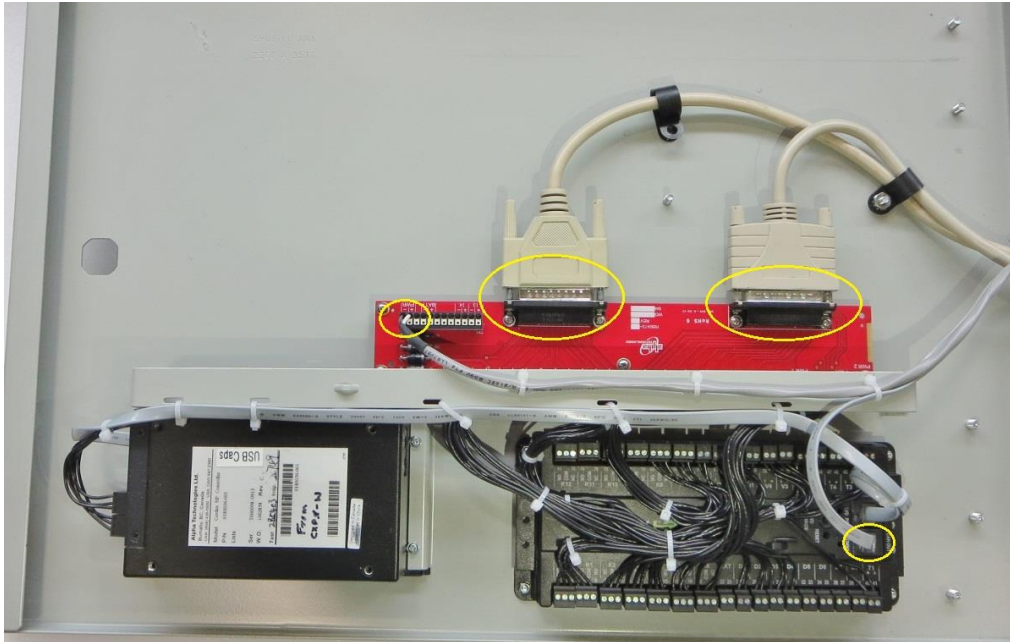

- 1.10. Ensure to observe correct polarity when connecting the power cable to the interface PCB power input terminal block.

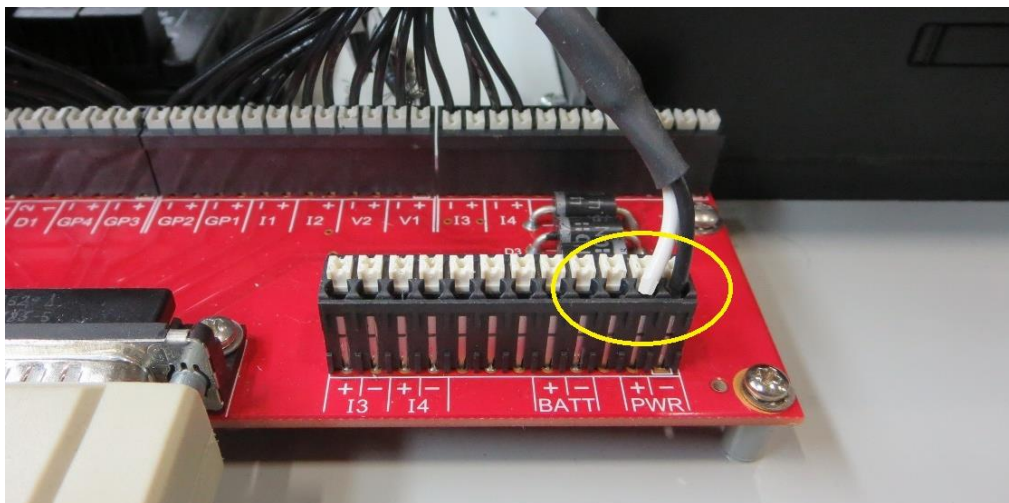

- 1.11. Install provided power feed cable using cable tie mounts and cable ties to the distribution bus observing correct polarity. Should also note that the CXC-HP and L-ADIO will power up at this stage and alarms will likely be present until the CXC-HP has been configured to the power system parameters.

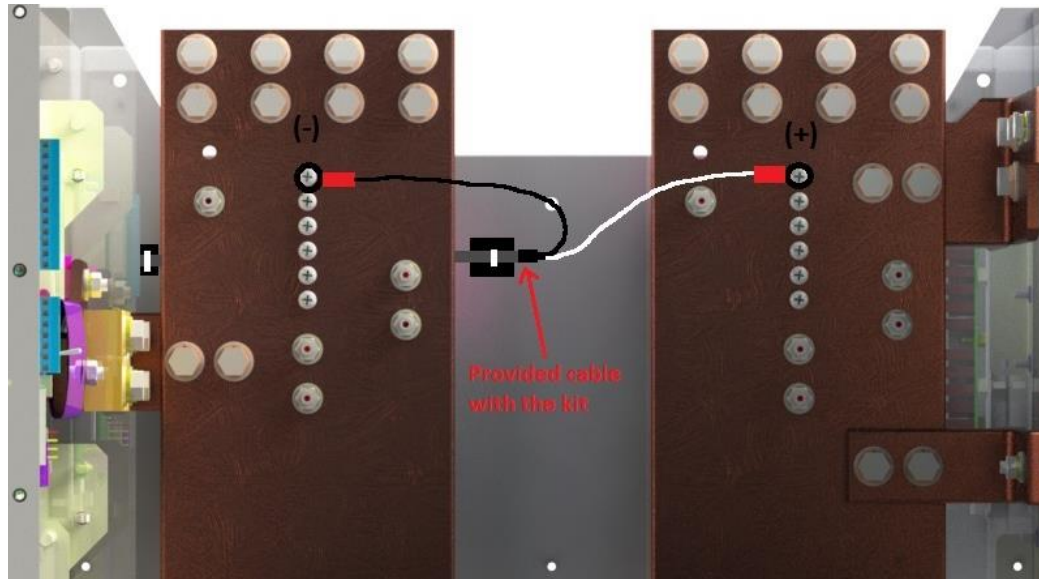

- 1.12. Bundle excess length of DB-25 cable with power feed and CAN cable.

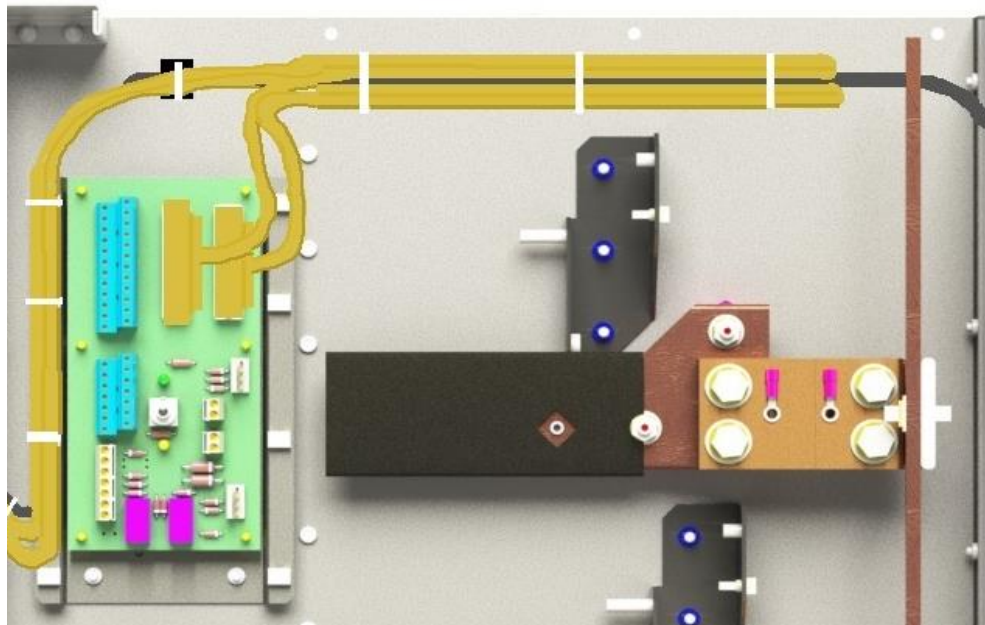

1.13. CXC-HP retrofit installation completed.

1.14. Refer to quick start guide “DCPS-QS” to configure the CXC-HP controller.

## 2) CXCM4 controller replacement with a rectifier module

2.1. Remove adjacent rectifier to the CXCM4 and bottom 2x rectifiers (if the system has more than one rectifier shelves). Refer to step 1.4 for CXCM4 controller removal procedure.

**Caution: Make sure power system has enough power to the load before remove the rectifiers.**





- 2.2. Remove CXCM4 interface adaptor from rectifier shelf, loosening bottom 2x screws and top 2x screws from the back side of the shelf. Discard the CXCM4 interface adaptor.

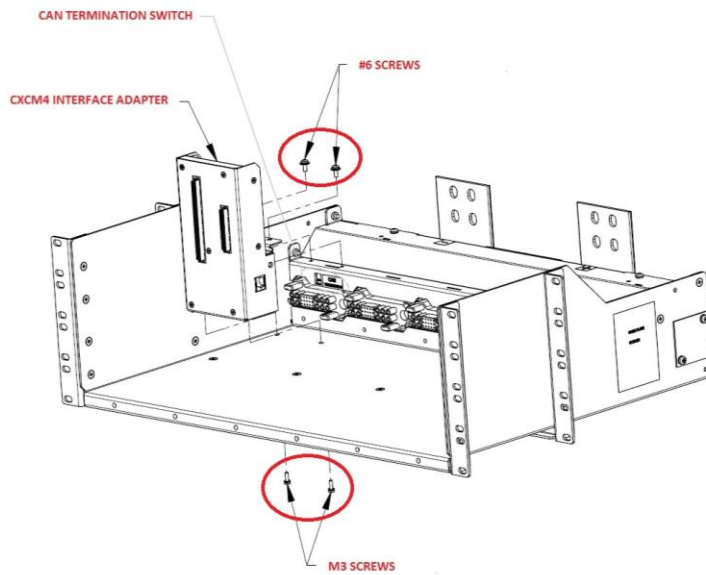

- 2.3. If the AC wiring is missing to module 1, make the AC connection using 30A breaker and #10 AWG wires (This apply only for rectifier shelves with List 85 AC input option,).

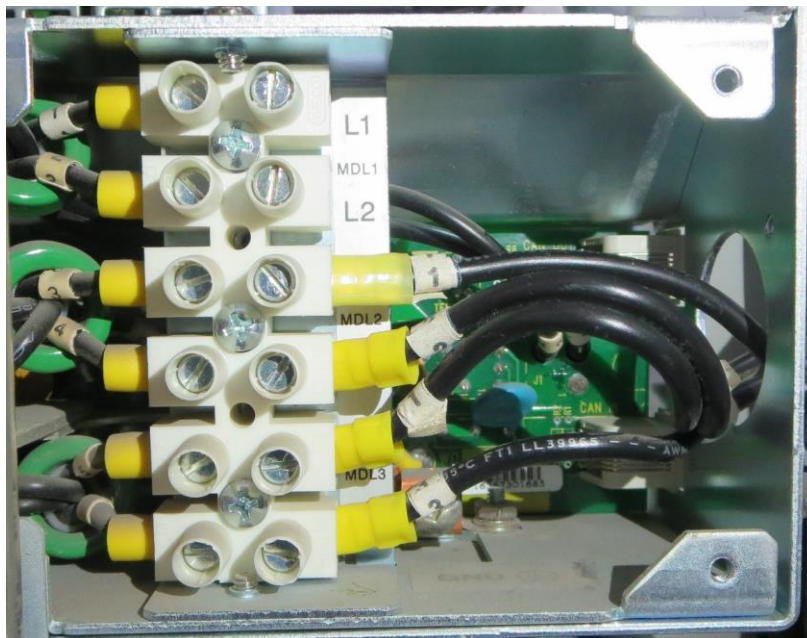

2.4. Install the new rectifier module and the rest of the removed modules in step 2.1.



2.5. CXCM4 controller replacement with a rectifier module procedure is completed.

### **End of Method of Procedures for kits 0380514-001 and 0380514-002**

### 3) CXCM4 Controller replacement steps for kit 0380514-003 (4 Tier)

3.1. Remove the existing distribution door by removing the 4x hinge nuts and ground strap nut.

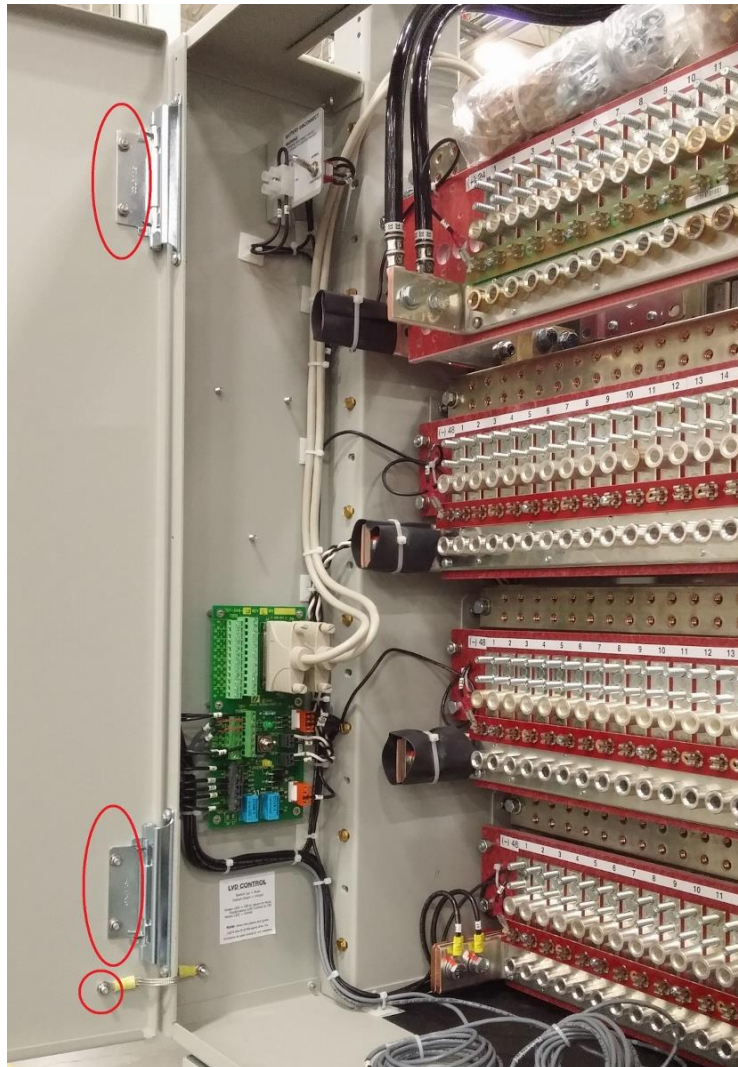

3.2. Remove the locks from the existing door and install in new door.

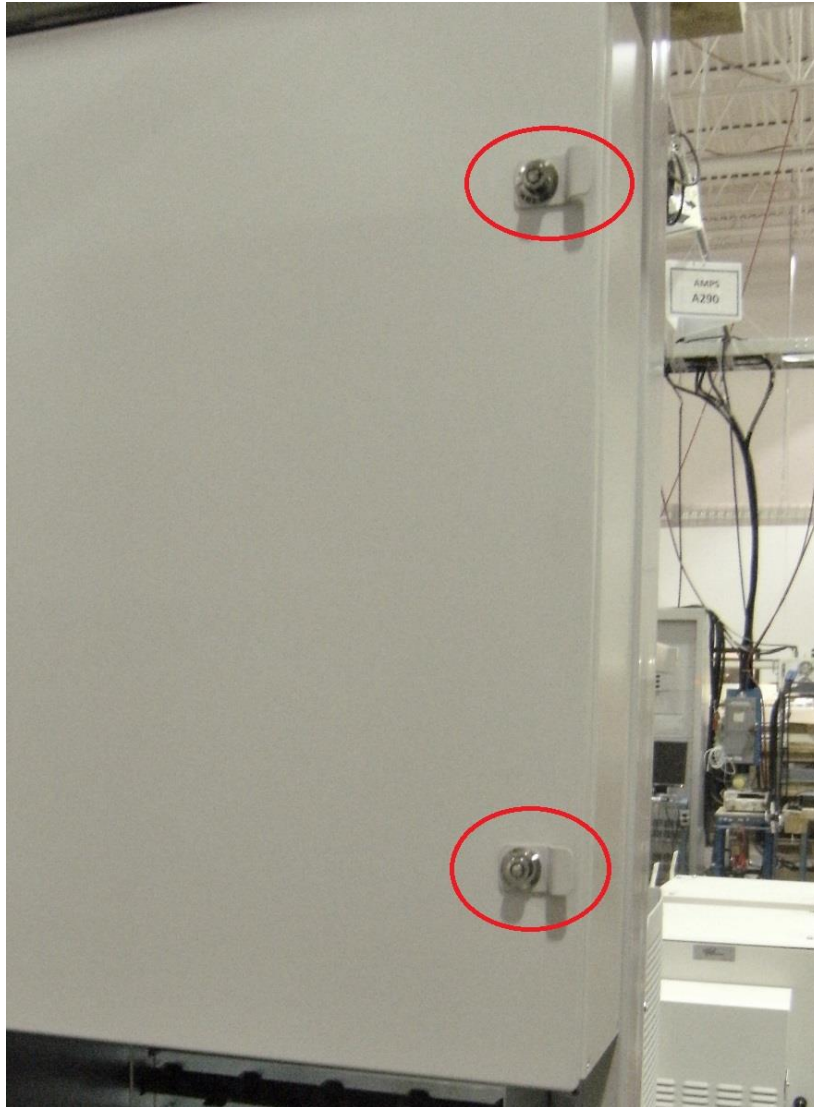

- 3.3. Install the new door and reattach the grounding strap using the same hardware removed in Step 3.1.

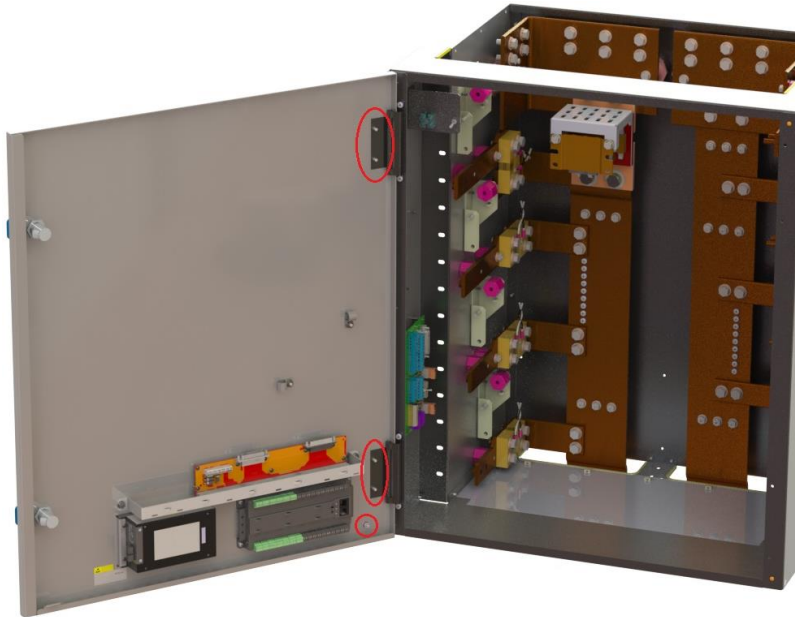

- 3.4. Remove CXCM4 controller module and install rectifier blank cover provided with the kit.



- 3.5. Disconnect 2x DB-25 cables and IDC connector with shunt wires at P5 from CXCM4 interface adapter.  
**(Caution: Do not cut the wires)**



- 3.6. Route only the 2x DB-25 cables in to the distribution. Do not move or remove any other wires from the interface PCBA (Item 1).

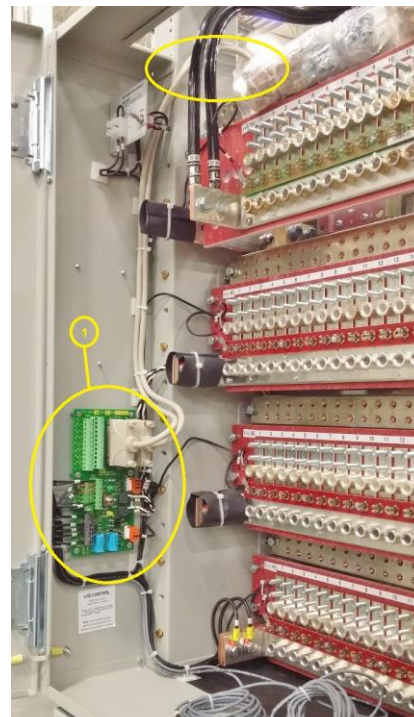

3.7. Connect routed 2x DB-25 cables to the interface PCB on the new door.

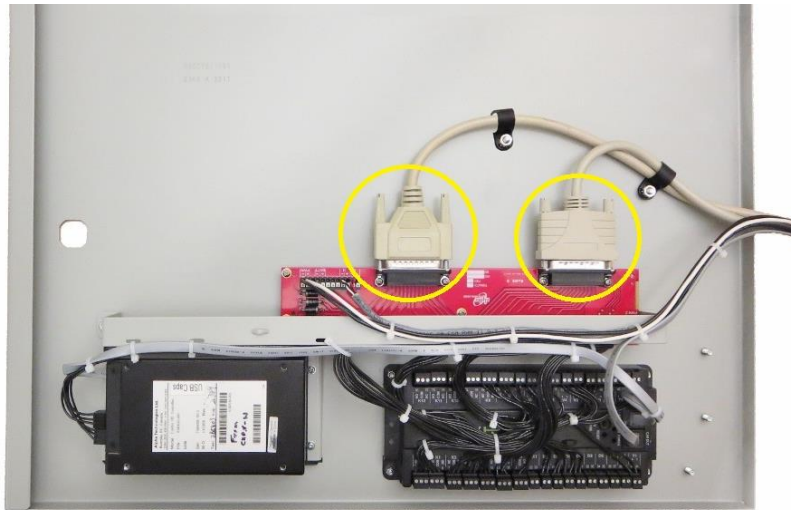

3.8. Route and secure (use tie raps and provided 2x P-clips) 2x DB-25 cables, power wires, 2 pair shunt cable and CAN cable in to the distribution.

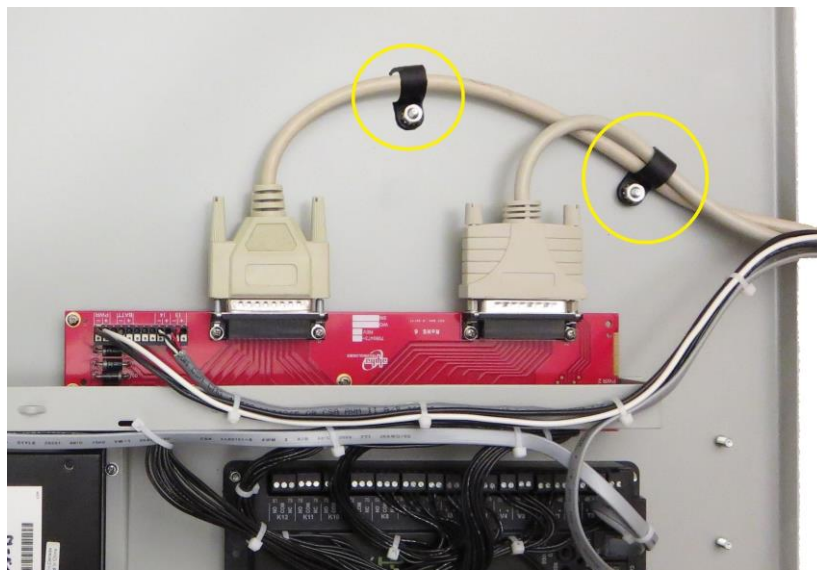

3.9. Connect Wire A and B from the interface PCB to terminal block in the distribution. Connect wire "A" with #17 and wire "B" with #16 parallel to existing wires along with diodes.

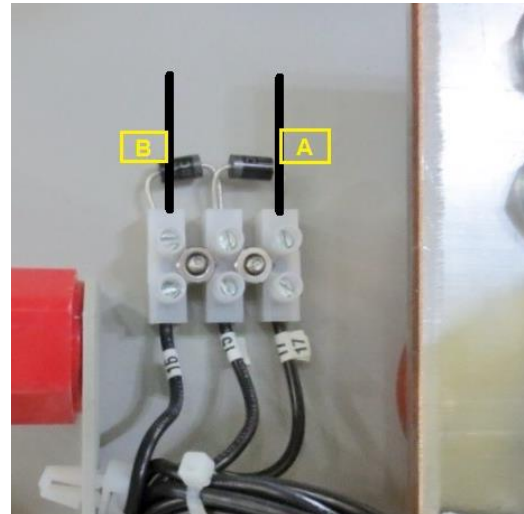
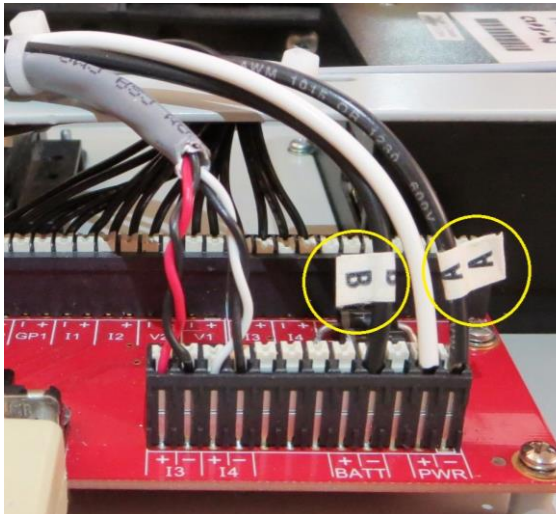

3.10. Connect white wire from interface PCB on the door to the interface PCB terminal block #44 (COMMON) in the distribution.

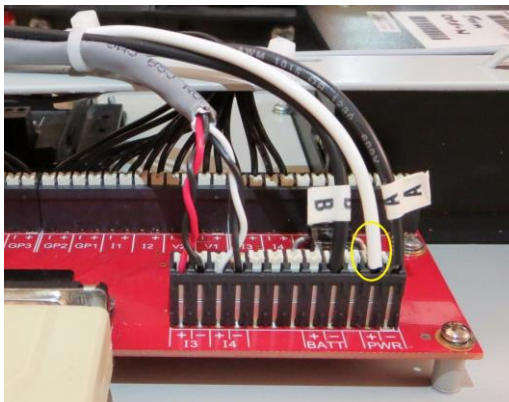



3.11. Bundle the excess 2x DB-25 cables, along with A and B wires tie on to provided mounting plates.

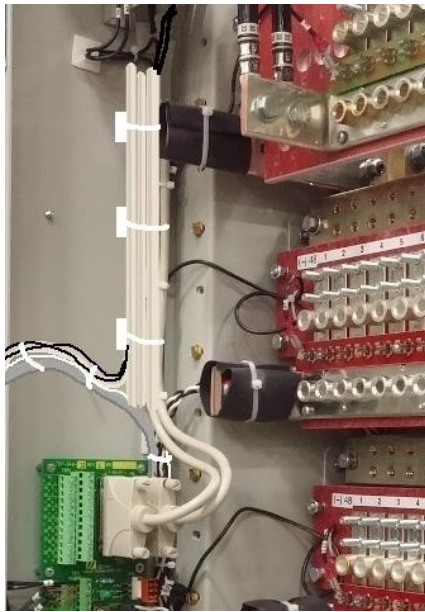

3.12. Route Shunt cable and CAN cable from bottom of the distribution.

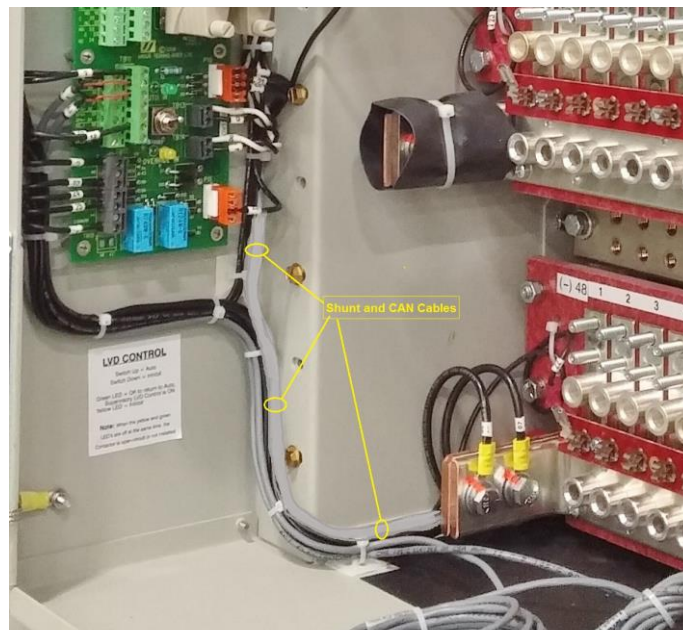

3.13. Move the shunt cable and CAN cable to the outside from the bottom back opening on the distribution.

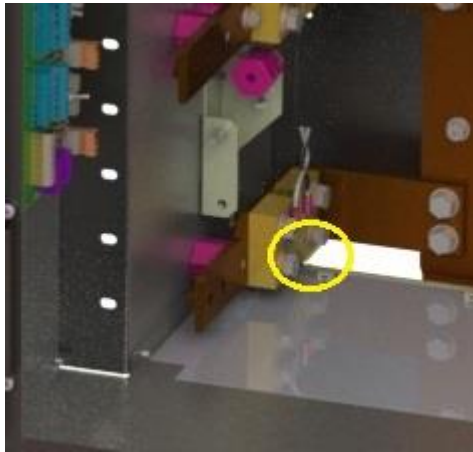

3.14. Connect provided CAN cable.

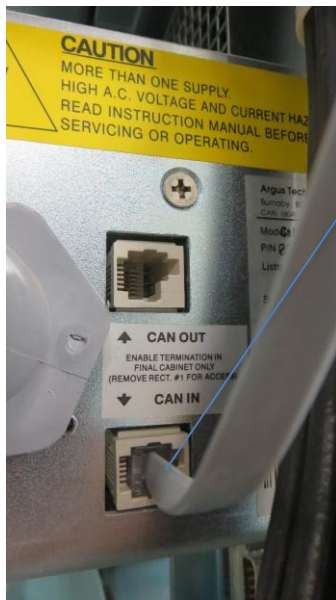

CAN cable from L-ADIO on a Single Rectifier Shelf system.

CAN cable from L-ADIO to a Top rectifier with more than one rectifier shelf system.



3.15. Assemble the provided terminal block carrier and strain relief plate together.

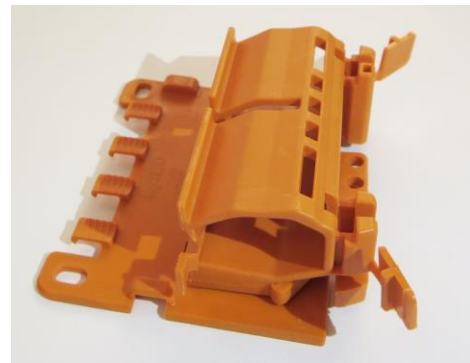
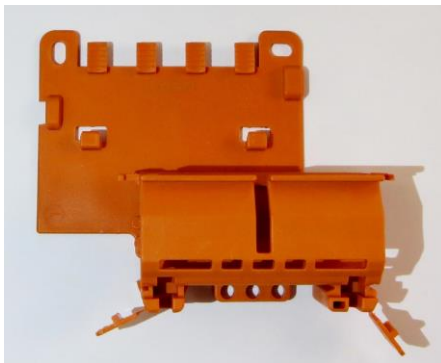

3.16. Open the hole using a small screwdriver.

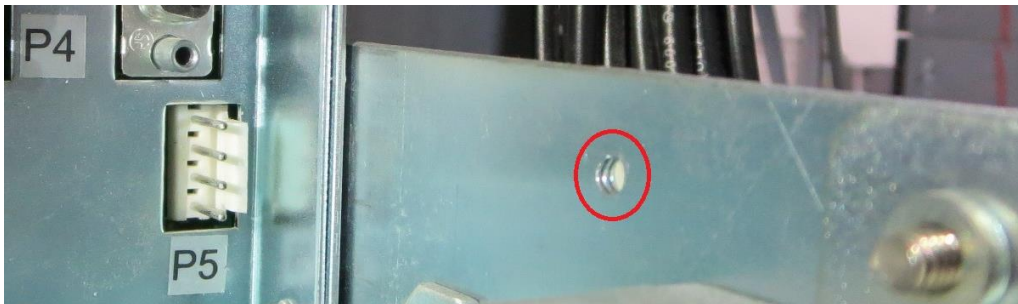

3.17. Install the provided terminal block carrier using provided screw, washer and nut.

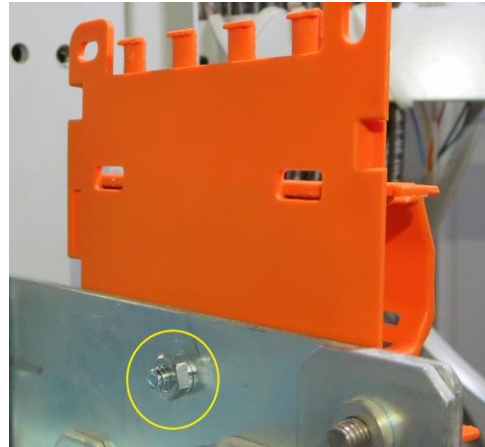
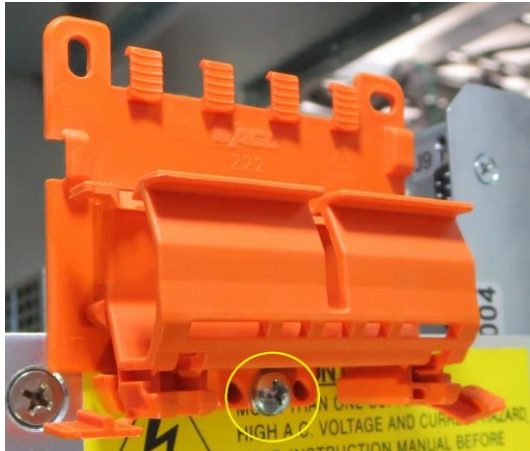

3.18. Cut a shunt wire #9 from item 1 (IDC connector), strip and install to provided terminal block (item 2). Repeat for wire #10, 11 and 12. Connect 2 pair shunt wires to provided terminal blocks. Follow the following table for wire connections.

**(Caution: Do not short the shunt wire with the chassis)**

Wire Tag #	Shunt Wire	2 Pair Cable	2 Pair single wire
9	BLACK	RED/BLACK	BLACK
10	WHITE		RED
11	BLACK	WHITE/BLACK	BLACK
12	WHITE		WHITE

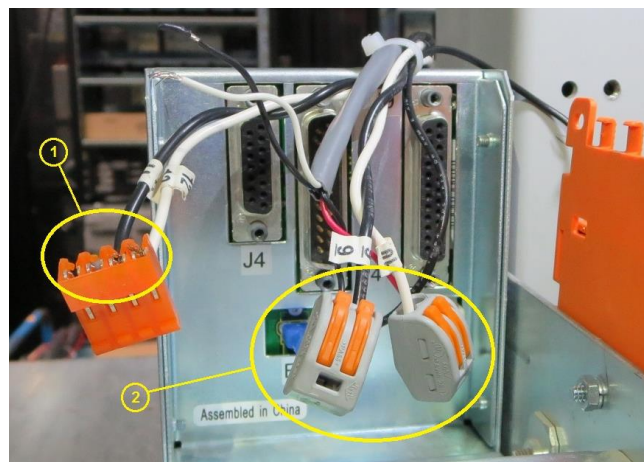

Shown only wire #9 and #10 connected to terminal blocks.

- 3.19. Slide terminal blocks in to the carrier and lock the tabs on the bottom and secure the wires with tie raps.

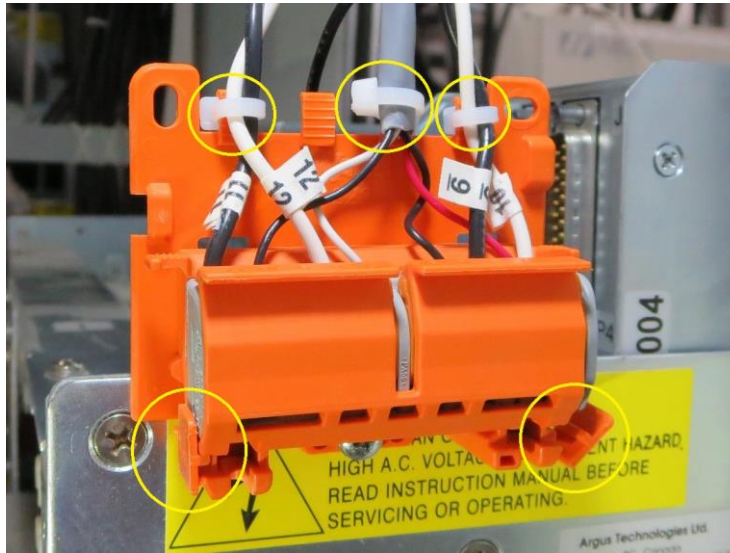

- 3.20. CXC-HP retrofit installation completed.

- 3.21. Refer to quick start guide "DCPS-QS" to configure the CXC-HP controller.

#### 4) CXCM4 controller replacement with a rectifier module

- 4.1. Remove adjacent rectifier to the CXCM4 and bottom 2x rectifiers (if the system has more than one rectifier shelves). Refer to step 3.4 for CXCM4 controller removal procedure.

**Caution: Make sure power system has enough power to the load before remove the rectifiers.**



- 4.2. Disconnect battery hot from E1. Secure the wire to a cable tie bracket. (This wire not being replaced by wire "B" at step 3.9).

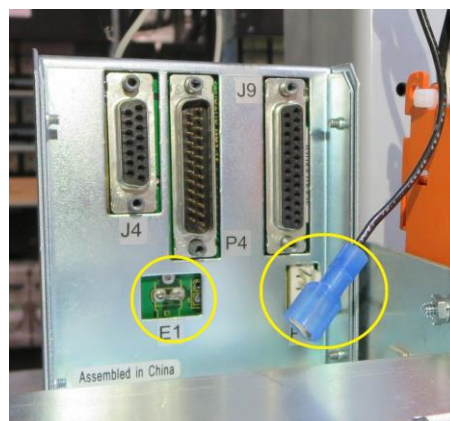

- 4.3. Remove CXCM4 interface adaptor from rectifier shelf, loosening bottom 2x screws and top 2x screws from the back side of the shelf. Discard the CXCM4 interface adaptor.

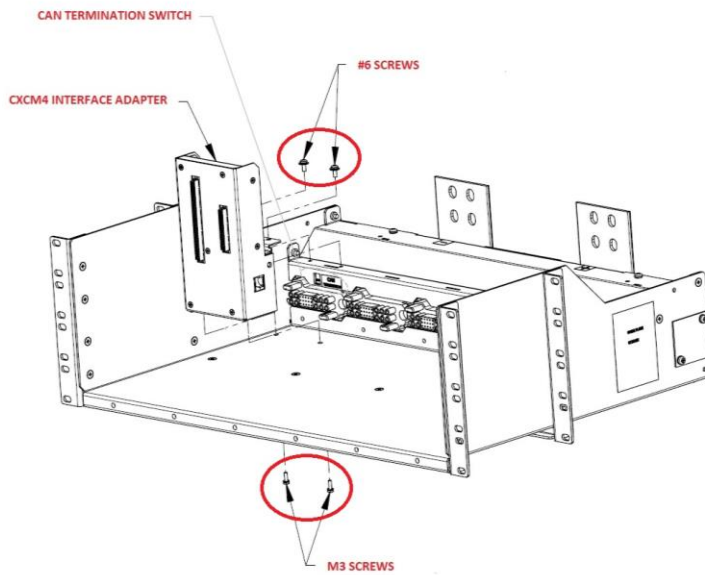

- 4.4. If the AC wiring is missing to module 1, make the AC connection using 30A breaker and #10 AWG wires (This apply only for rectifier shelves with List 85 AC input option,).

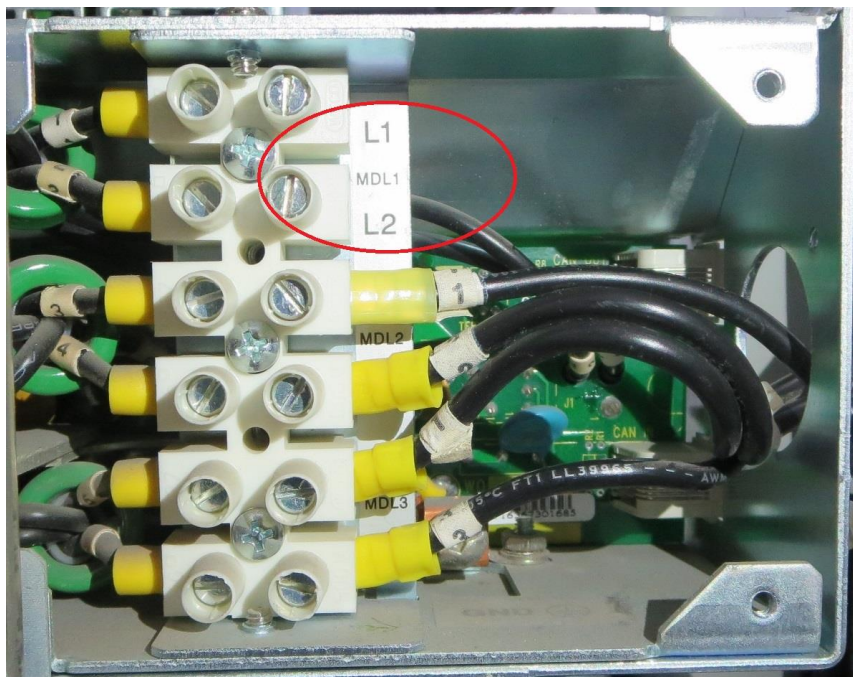

- 4.5. Install the new rectifier module and the rest of the removed modules in step 4.1.



- 4.6. CXCM4 controller replacement with a rectifier module procedure is completed.

### **End of Method of Procedure for kit 0380514-003**

**For assistance, contact Alpha Technical Support:** Toll Free North America: 1-888-462-7487  
International: +1-604-436-5547  
Monday - Friday, 7:00 AM - 5:00 PM PST for regular inquiries  
24/7 for emergency support  
[Click here to report a problem](#)

*Your Power Solutions Partner*

F-MKT-04 Rev 1.1

Copyright © 2017 Alpha Technologies. All Rights Reserved. Alpha® is a registered trademark of Alpha Technologies.  
Member of The Alpha Group™ is a trademark of Alpha Technologies.

For more information visit [www.alpha.ca](http://www.alpha.ca)

0380514-F0 Rev A (12/2017)  
Member of the Alpha Group